

PHIRE-S™ Single Fiber Series

KEY FEATURES

- ❖ Single fiber bi-directional data transmission
- ❖ LC optical connector
- ❖ Fully supports base Camera Link™ cameras/frame grabbers
- ❖ Direct plug – no electrical cable needed
- ❖ Broad bandwidth – up to 2.5 Gb/s supporting 24 bits image data at 85 MHz pixel clock
- ❖ Transparent operation – plug and play with no changes required for camera and/or frame grabber
- ❖ Single 5V~24V DC power supply
- ❖ Exchangeable optical module – easy to upgrade
- ❖ Estimated transmission distance - up to 500 m for 50/125 μm MM fiber and 10 km for SM fiber
- ❖ **PoCL compatible**
- ❖ **Compact size – 59L x 39.4W x 17H mm (2.326L x 1.551W x 0.669H inch)**

TARGET APPLICATIONS

- ❖ Solar panel or glass panel inspection
- ❖ Semiconductor wafer inspection
- ❖ High speed printing inspection
- ❖ High precision surface inspection (e.g. airplane surface or automobile painting)
- ❖ Automated product inspection (e.g. food, drinking or pharmaceutical products)
- ❖ High resolution and real-time analysis for science, sports, automobile tests, and 3-D animation.
- ❖ High precision security surveillance (e.g. border control, airport)
- ❖ Traffic surveillance/control and vehicle license plate reading/recording (e.g. toll booth)
- ❖ Cameras placed in harsh environment (e.g. nuclear plant, steel mill or undersea monitoring)
- ❖ Other Machine Vision Applications

PHRONTIER™
TECHNOLOGIES

PHIRE-S™ Camera Link Single Fiber Adapter

Base Configuration

PHL-68-M50/S10
PHL-85-M50/S10
PHL-85-M25/S07



Phrontier Technologies, LLC
www.phrontier-tech.com
sales@phrontier-tech.com
Toll Free: 1-866-389-2829
Fax: 1-801-998-1855

TYPICAL SET UP DIAGRAM

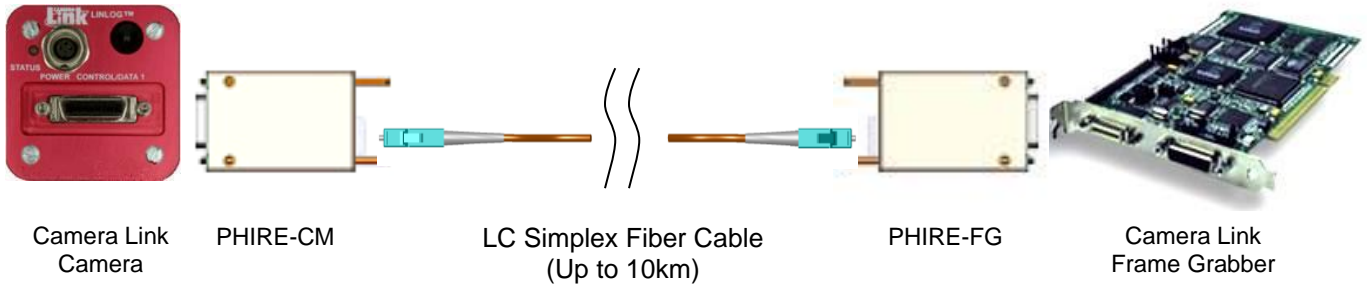

TECHNICAL SPECIFICATIONS

General Specification

Standard Operating Temperature	Ambient	0 ~ 50 °C	Case	0 ~ 60 °C
Extended Operating Temperature	Ambient	-40~70 °C	Case	-40~80 °C
Storage Temperature	-40 ~ 85 °C			
Operating Humidity	20 ~ 80% (non-condensing)			
Input Voltage	DC 5 ~ 24 V			
Supply Current @25 °C	0.160 A @12V each module			
Typical Power Consumption	1.9 W each module			
Connector Type	Micro USB type B with custom pin assignment			
Approx. Weight (each module)	75 gram			

Camera Link Interface

	PHL-68-M50 PHL-68-S10	PHL-85-M50 PHL-85-S10	PHL-85-M25 PHL-85-S07
Max Pixel Clock	68 MHz	85 MHz	85 MHz
Max Image Data Width	24 bits	16 bits	24 bits
Transport Bandwidth	2 Gb/s	2 Gb/s	2.5 Gb/s
Connector Type	MDR26 plug		

Optical Interface

	PHL-68-M50 PHL-85-M50	PHL-85-M25	PHL-68-S10 PHL-85-S10	PHL-85-S07
Operating Wavelength	1310nm (CM) 1550nm (FG)	1310nm (CM) 1550nm (FG)	1310nm (CM) 1550nm (FG)	1310nm (CM) 1550nm (FG)
Min Optical Tx Output Power	-3 ~ -9 dBm	-3 ~ -9 dBm	-3 ~ -10 dBm	-3 ~ -8 dBm
Min Optical Rx Power	-15 dBm	-15 dBm	-18 dBm	-16 dBm
Connector Type	LC simplex			
Fiber Type	50/125 μm or 62.5/125 μm MM fibers		9/125 μm SM fibers	

MECHANICAL INFORMATION (mm [inch])

No Mounting Brackets

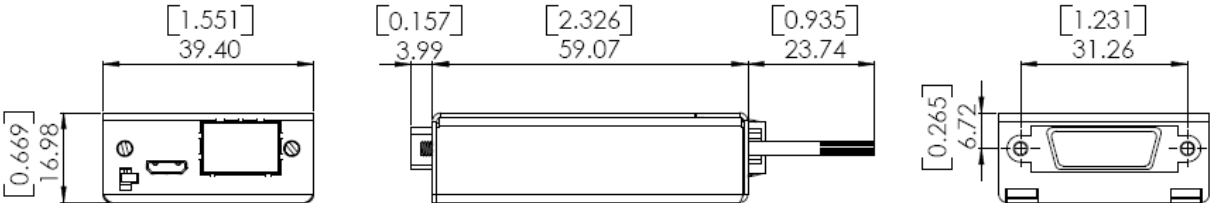

With Mounting Flange Options

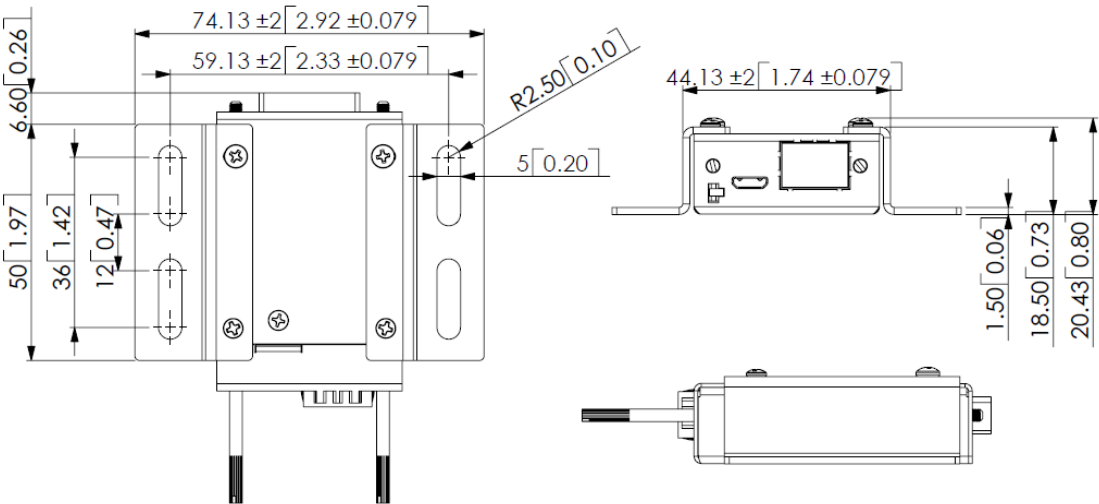

SDR plug to MDR receptacle adapter

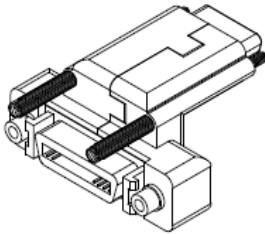
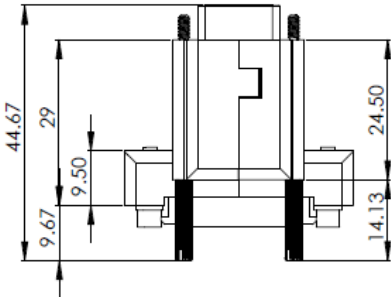

Down angle configuration

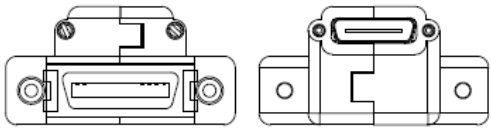

Up angle configuration

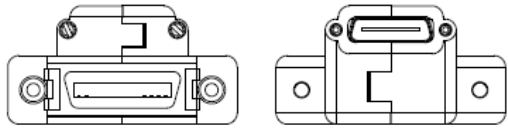
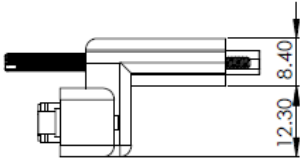
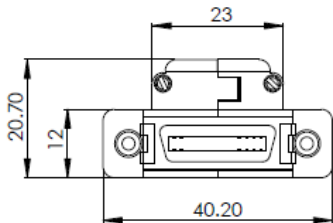

ORDERING INFORMATION

Standard models

Model #	Data Width	Max Pixel Clock Rate	Transport Distance*	Connector	Items Provided
PHL-68-M50	24 bit	68 MHz	500 m	LC	1x PHIRE-CM (transmitter) 1x PHIRE-FG (receiver) 2x 12V DC output international wall mount AC/DC power adapters with snap locking plug (Fiber cable not included)
PHL-68-S10	24 bit	68 MHz	10 km	LC	
PHL-85-M50	16 bit	85 MHz	500 m	LC	
PHL-85-S10	16 bit	85 MHz	10 km	LC	
PHL-85-M25	24 bit	85 MHz	250 m	LC	
PHL-85-S07	24 bit	85 MHz	5 km	LC	

Extended temperature models

Model #	Data Width	Max Pixel Clock Rate	Transport Distance*	Connector	Items Provided
PHL-68-M50-T	24 bit	68 MHz	500 m	LC	1x PHIRE-CM (transmitter) 1x PHIRE-FG (receiver) 2x 12V DC output international wall mount AC/DC power adapters with snap locking plug (Fiber cable not included)
PHL-68-S10-T	24 bit	68 MHz	10 km	LC	
PHL-85-M50-T	16 bit	85 MHz	500 m	LC	
PHL-85-S10-T	16 bit	85 MHz	10 km	LC	
PHL-85-M25-T	24 bit	85 MHz	250 m	LC	
PHL-85-S07-T	24 bit	85 MHz	5 km	LC	

* Distance depending on fiber type and system design. Transmission distance above is estimated minimum distance for 50/125 OM2 MM fiber and 9/125 SM fiber. Extra optical losses in the system will reduce the transmission distance.

Accessory

Part #	Description
618-TRG10R-MUSB-1	12V DC international wall mount AC/DC adapter with micro-USB plug
LC-LC-MS-xxM2	LC to LC simplex 50/125 μ m OM2 MM fiber. xx = length in meters.
LC-LC-MS-xxM3	LC to LC simplex 50/125 μ m OM3 MM fiber. xx = length in meters.
PHIRE-W	1 pair of mounting flanges
SDR-MDR-D	SDR plug to MDR receptacle adapter – DOWN configuration
SDR-MDR-U	SDR plug to MDR receptacle adapter – UP configuration



www.phrontier-tech.com

sales@phrontier-tech.com

1-866-3892829

The Camera Link™ term and the Camera Link logo are registered trademarks of AIA. Phrontier™ and PHIRE-S™ are trademarks of Phrontier Technologies, LLC. All rights reserved. Copy Right © 2019