

Datasheet

Features

- Cmos Colour Sensor :
 - 16384 RGB Pixels, 5 x 5µm (Full Definition)
 - 8192 RGB Pixels 10x10µm (True Colour)
- Interface : CoaXPress® (4x 6Gb/sLinks)
- Line Rate :
 - Up to 47500 l/s In 16k Full Definition Mode
 - Up to 95000 l/s in 8k True Colour Mode
- Bit Depth : 24bits (RGB 8bits)
- Efficient color interpolation
- Scan Direction
- Flat Field Correction
- Low Power Consumption : <19W
- Compliant with Standard Lenses of the Market



Description

e2v's next generation of line scan cameras are setting new, high standards for line rate and image quality. Thanks to e2v's recently developed multi-line CMOS technology, the camera provides an unmatched 95,000 lines/s and combines high response with an extremely low noise level; this delivers high signal to noise ratio even when short integration times are required or when illumination is limited. The 5µm pixel size is arranged in four active lines and dual line filter configuration allowing the camera to be operated in several modes: True colour mode with 10µm RGB pixels to provide equivalent colour fidelity to 10µm pixel tri-linear solutions with advanced immunity to web variation or Full definition mode with a unique 16,384 RGB pixel resolution.

Application

- Printing Inspection
- High Resolution Document Scanning
- Printed Circuit Board Inspection
- Flat Panel Display Inspection
- High Quality Raw material Surface Inspection



GEN<i>i>CAM

Key Specifications

Characteristics	Typical Value		Unit
Sensor Characteristics at Maximum Pixel Rate			
Resolution	16384	8192	RGB Pixels
pixel size (square)	5	10	μm
Max line rate	47.5	95	
Radiometric Performance at Maximum Pixel Rate and minimum camera gain			
Bit depth	3 x 8		Bits
Response non linearity	< 1		%
PRNU HF Max	3		%
Dynamic range	65		dB
Response (Peak) : True Color or Full Def. Enhanced			
Red	11.8		LSB 8bits/(nJ/cm ²)
Green	11.2		LSB 8bits/(nJ/cm ²)
Blue	7.8		LSB 8bits/(nJ/cm ²)

Functionality (Programmable via GenICam Control Interface)			
Analog Gain	Up to 12 (x4)		dB
Offset	-4096 to +4096		LSB
Trigger Mode	Timed (Free run) and triggered (Ext Trig, Ext ITC) modes		
Sensor Modes	<ul style="list-style-type: none"> • True Color Enhanced : 8192 RGB Pixels of 10x10μm • True Color Single : 8192 RGB Pixels of 10x10μm • Full Definition Enhanced : 16384 RGB Pixels 5x5μm • Full Definition Single : 16384 RGB Pixels 5x5μm 		
Mechanical and Electrical Interface			
Size (w x h x l)	100 x 156 x 36		mm
Weight	700		g
Lens Mount	M95 x 1		-
Sensor alignment (see chapter 4)	±100		μm
Sensor flatness	±35		μm
Power supply	Power Over CoaXPress : 24		V
Power dissipation – Typ. while grabbing	< 19		W
General Features			
Operating temperature	0 to 55 (front face) or 70 (Internal)		°C
Storage temperature	-40 to 70		°C
Regulatory	CE, FCC and RoHS compliant		

Image Sensor

The Eliixa+ Colour 16k sensor is composed of two pairs of sensitive lines. The Colour version has been completed with RGB colour Filter and disposed as detailed beside.

Each pair of lines use the same Analog to Digital Column converter (ADC Column). An appropriate (embedded) Time delay in the exposure between each line this allows to combine two successive exposures in order to double the sensitivity of a single line.

This Time Delay Exposure is used only in the Full Definition Enhanced.

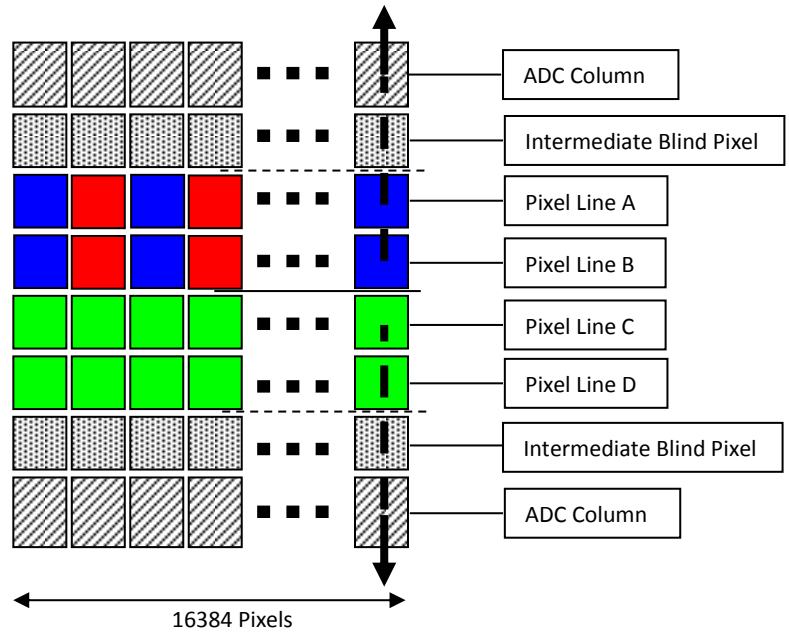

Full Definition Single Mode (FDS)

5 μ m Pixels (R,G,B)

Same definition than B&W

Requires x3 the data flow of the B&W

- Sensitivity is half of the TC mode available : Equivalent to 3 x Pixels of 5 μ m (with their respective colour filters).
- "Full Exposure control" not needed in this mode as the Time Delay Exposure is not active. The Exposure time can be control as for a single line mode.

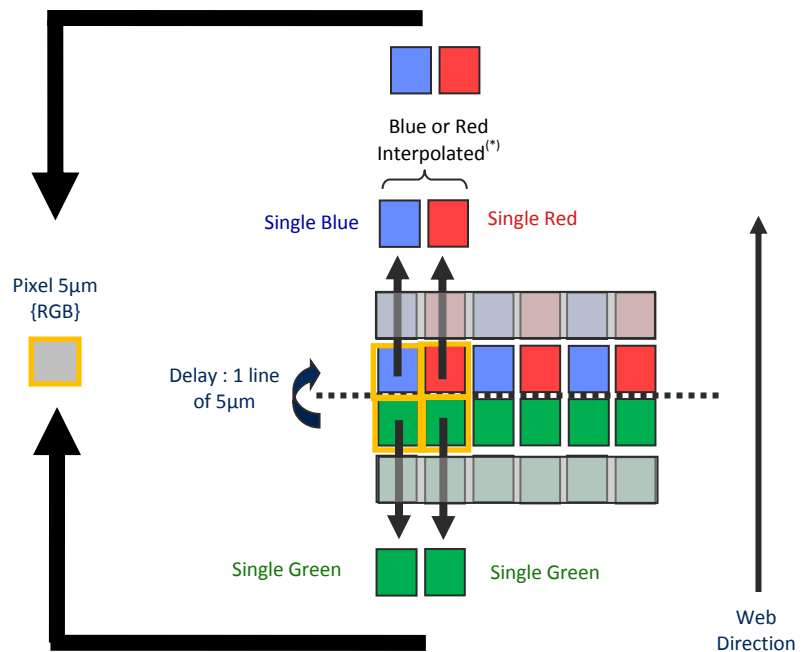

Full Definition Enhanced Mode (FDE)

5µm Pixels (R,G,B)

Same definition than B&W

Requires x3 the data flow of the B&W

- Sensitivity is the same as the TC mode available : Equivalent to 6 x Pixels of 5µm (with their respective colour filters).
- “Full Exposure control” is activated in this mode as the Time Delay Exposure is active.

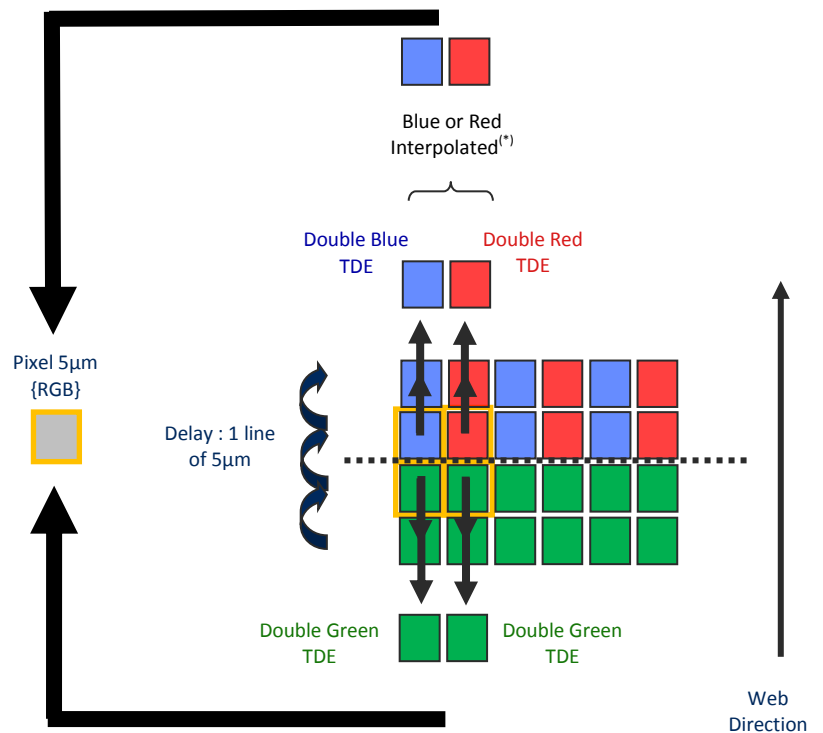

Color Interpolation in Full Definition modes.

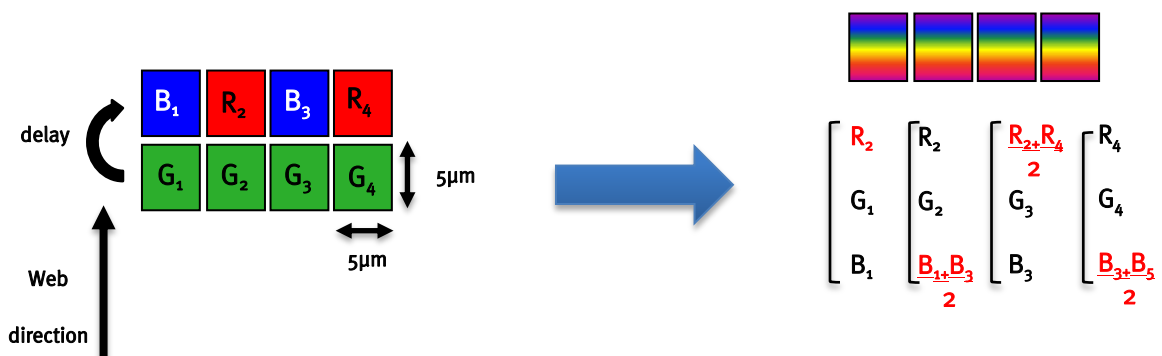

This color mode (5µm) requires the indication of “Forward/Reverse” to the camera in order to manage the delay between the two coloured lines.

True Colour Enhanced Mode (TCE)

10µm Pixels (R,G,B)
 Twice less pixels than B/W
 Requires $\times 3/2$ the data flow of B&W

- High Sensitivity True Color mode: Equivalent to 6 x Pixels of 5µm (with their respective colour filters).
- “Full Exposure control” not needed in TC as the TDI is not active (only binning). The Exposure time can be control as for a single line mode.

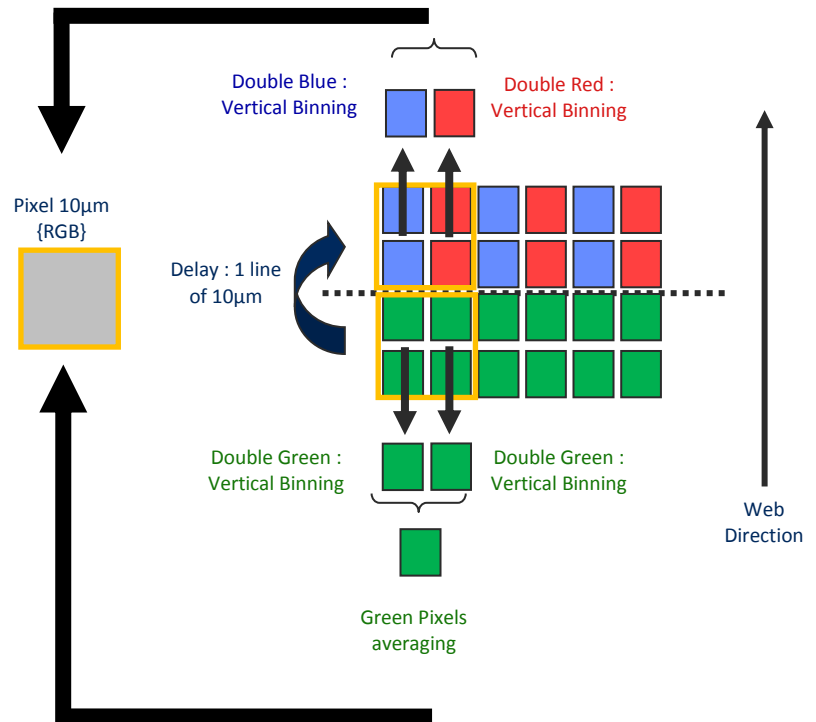

True Colour Single Mode (TCS)

10µm Pixels (R,G,B)
 Twice less pixels than B/W
 Requires $\times 3/2$ the data flow of B&W

- Sensitivity Half of the TCE mode: Equivalent to 6 x Pixels of 5µm (with their respective colour filters).
- “Full Exposure control” not needed in TC as the TDI is not active (only binning). The Exposure time can be control as for a single line mode.
- Not sensitive to the Scanning direction and the variation of the aspect ratio of the image.

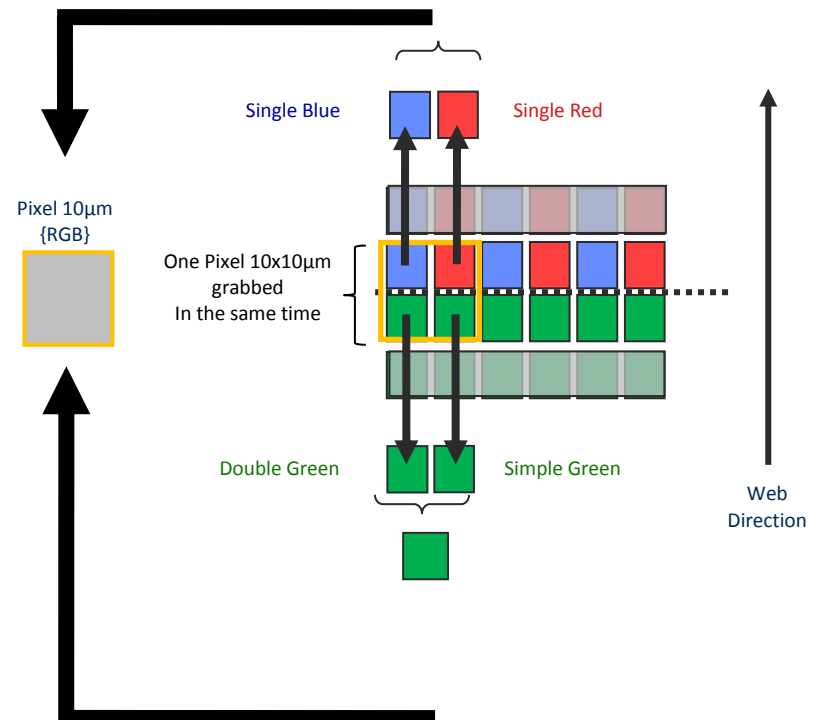

Column Interpolation Correction

This interpolation is used to compensate the color error in the Red or the Blue in case of a vertical transition on the web : The Red of the blue value of each colored pixel is corrected if the variation between two neighbour green pixels is significant.

$B_1' = \alpha_B \times B_1$ and α_B is the blue correction, calculated with the variation $(G_1 - G_2)$

$R_2' = \alpha_R \times R_2$ and α_R is the red correction, calculated with the variation $(G_1 - G_2)$

- This interpolation is available for all pixel sizes : 5x5µm but also 10x10µm
- It can be disabled by the customer. By default, it is enabled.

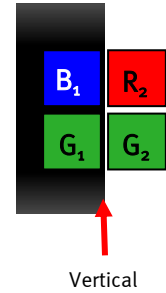

Line Interpolation Correction

This interpolation is used to compensate the color error in the Red or the Blue in case of a horizontal transition on the web in the same "True Color" pixel : A line is memorized and the Red of the blue value of each colored pixel is corrected if the variation between two consecutive green values (previous to next line) is significant :

$B_1' = \alpha_B \times B_1$ and α_B is the blue correction, calculated with the variation $(G_1 - G'_1)$

$R_2' = \alpha_R \times R_2$ and α_R is the red correction, calculated with the variation $(G_2 - G'_2)$

- This interpolation is available only for pixel size 10x10µm (True Color Single only)
- It can be enabled by the customer. By default, it is disabled
- This interpolation requires the Forward/Reverse indication sent to the camera for the memorized line.

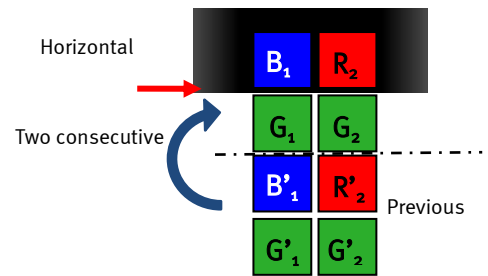

Effects of the interpolations

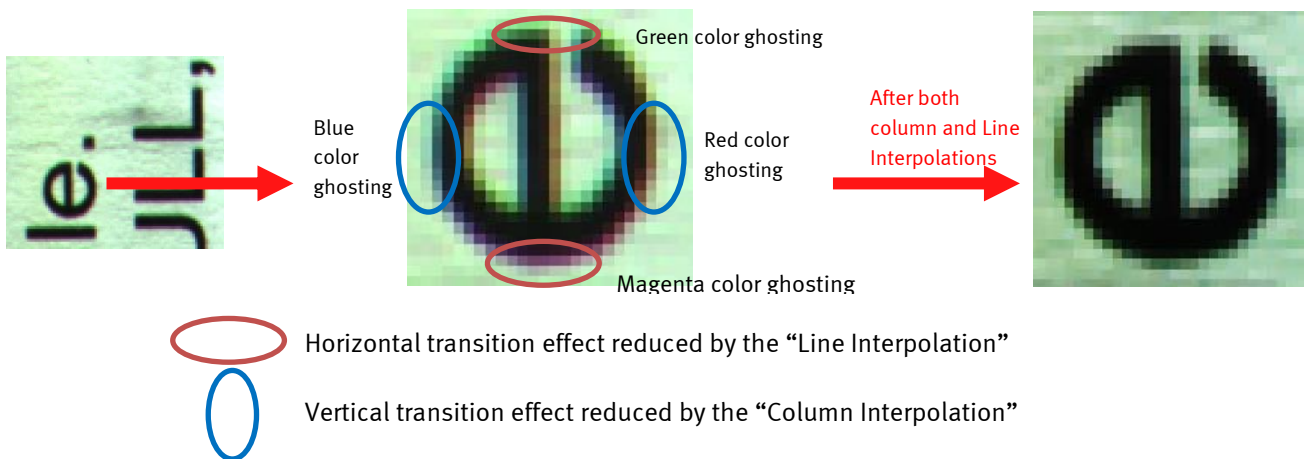

Response & QE curves

Quantum Efficiency

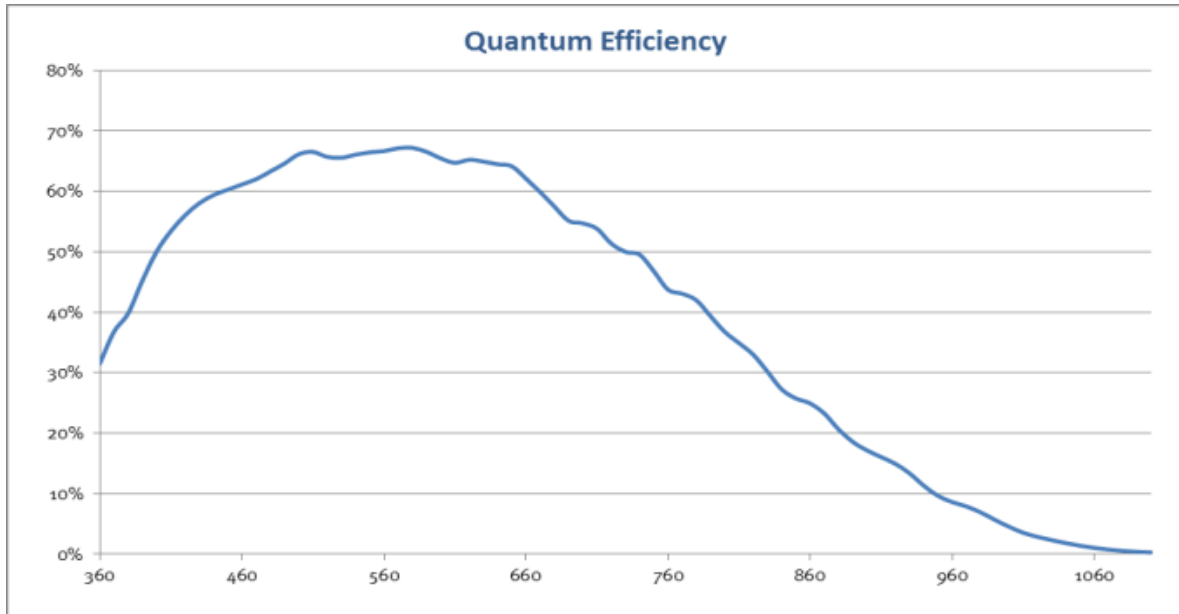

Spectral Response Curve

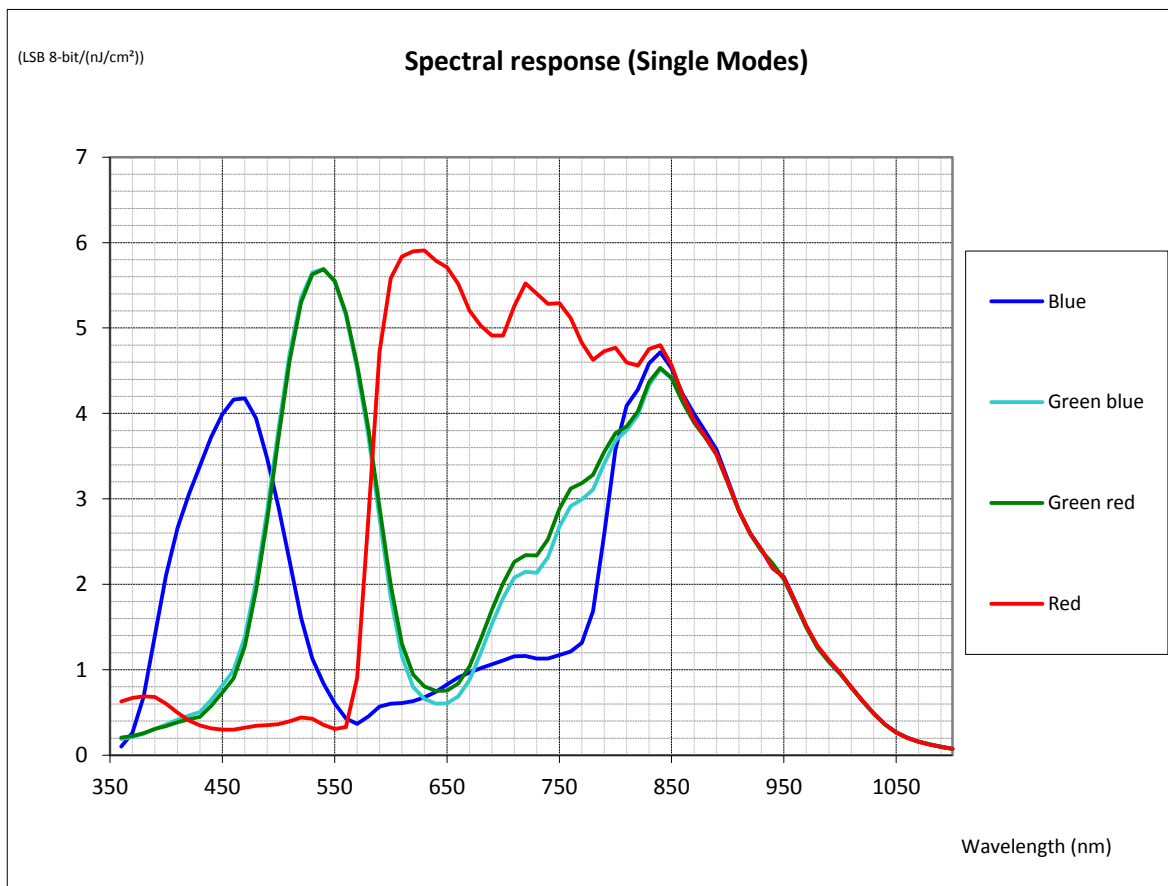

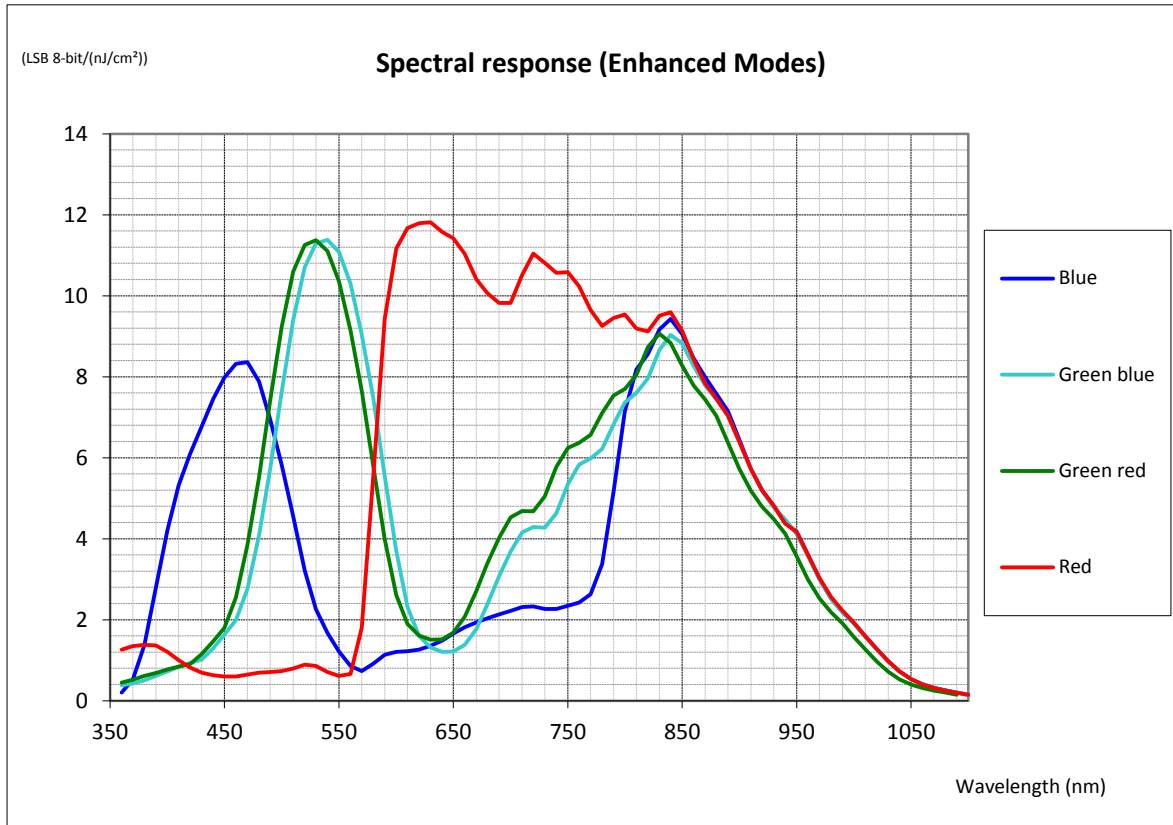

Hardware

Mechanical Drawing

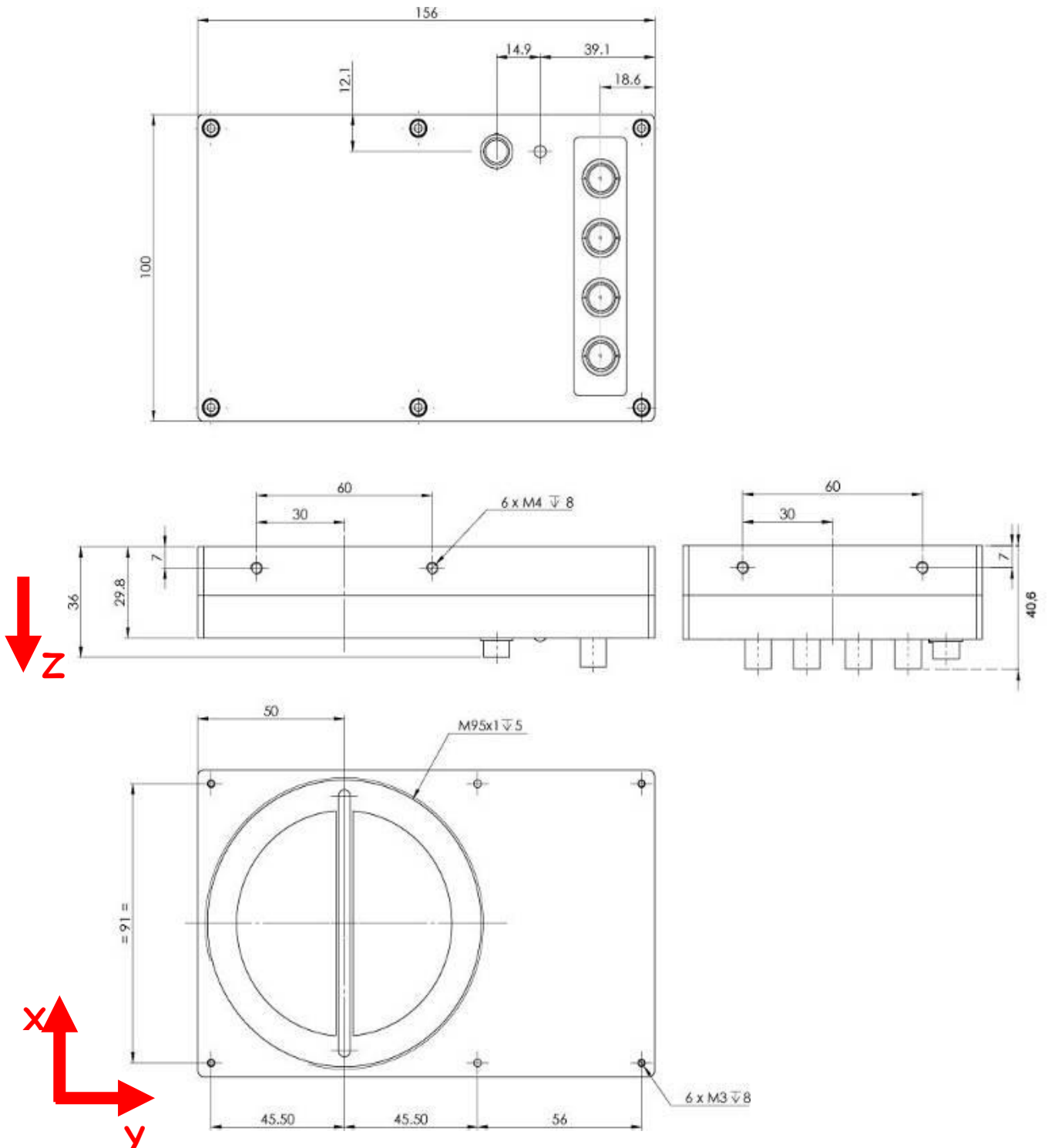

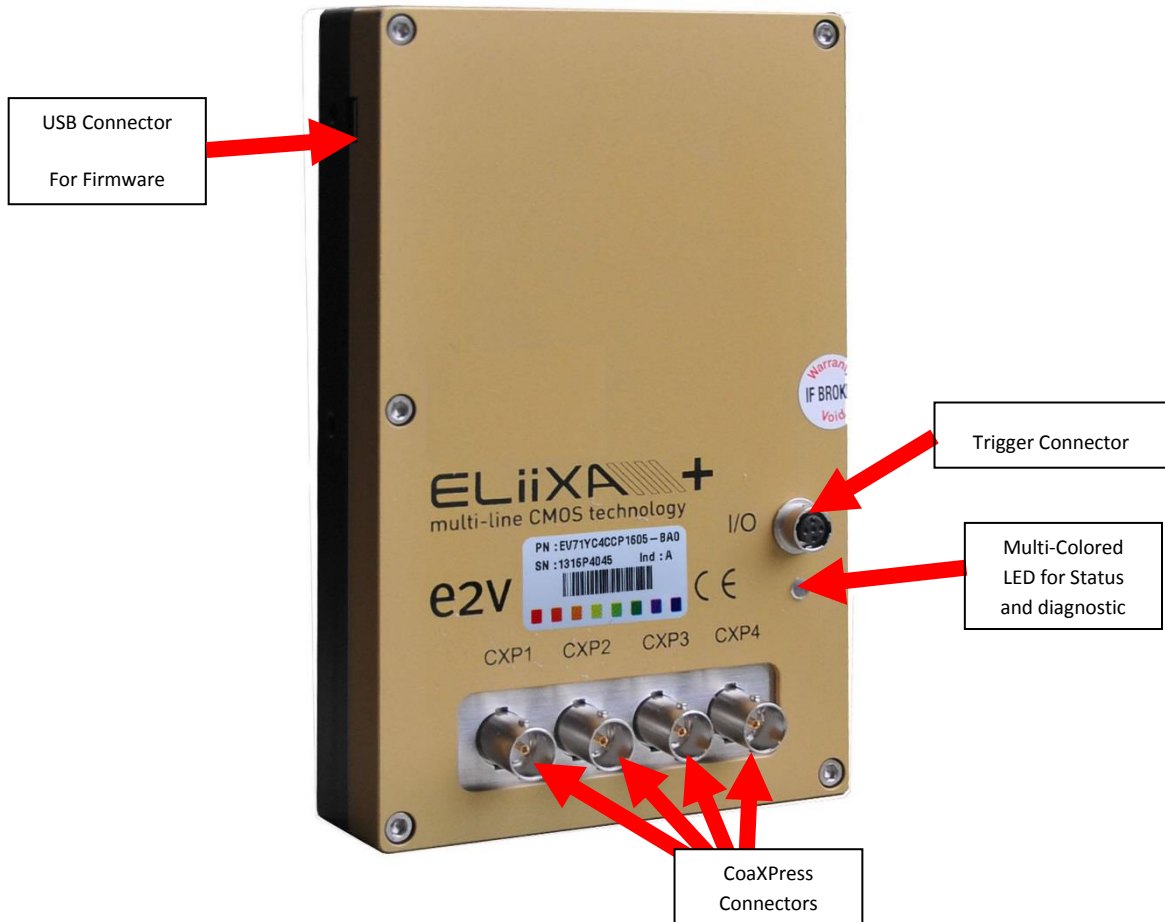

Power Over CoaXPress

The ELIIXA+ CXP is compliant with the Power Over CoaXPress : There is no Power connector as the power is delivered through the Coaxial Connectors 1 and 2.

In the Standard, the Power Over CoaXPress allows to deliver 13W (under 24V) per Channel.

The ELIIXA+ CXP requires 19W then two connectors are required for the power : The two first are used for this purpose.

If you want to Power ON the Camera you have to connect the Coaxial connector output 1 of the camera to the coaxial connector 1 of the Frame Grabber.

Note 1 : Only the connector 1 position is mandatory. They other 3 connectors can be inverted but the camera still needs the 2 first connectors to get it power and be able to start up.

Note 2 : Removing the 2 first connectors will shut down the Camera : You can reset the Camera by quickly (**less than 1s**) connect/disconnect the Connector CXP1 but after a longer shut down, you'll have to reboot the PC with the Camera full connected to the frame grabber in order to synchronize the discovery of each power line.

Note 3 : With some frame grabber you have access to a specific command (from the Frame Grabber interface) for shutting down/up the power of the CoaxPress : This solution, with the complete reboot, is the better solution to ensure a complete power On of the Camera.

Trigger Connector

Camera connector type: Hirose HR10A-7R-5SB or compliant

Cable connector type: Hirose HR10A-7P-5P (male) or compliant, Provided with the Camera

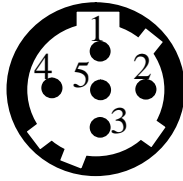

Receptacle viewed from camera back

Signal	Pin
LVDS IN1+ / TTL IN1	1
LVDS IN1-	2
LVDS IN2+ / TTL IN2	3
LVDS IN2-	4
GND	5

IN1/IN2 are connected respectively to Line0/Line1 and allow to get external line triggers or the forward/Reverse "Live" indication.

On the Connector side, the 120Ω termination is validated only if the input is switched in LVDS or RS422. The electrical schematic is detailed below :

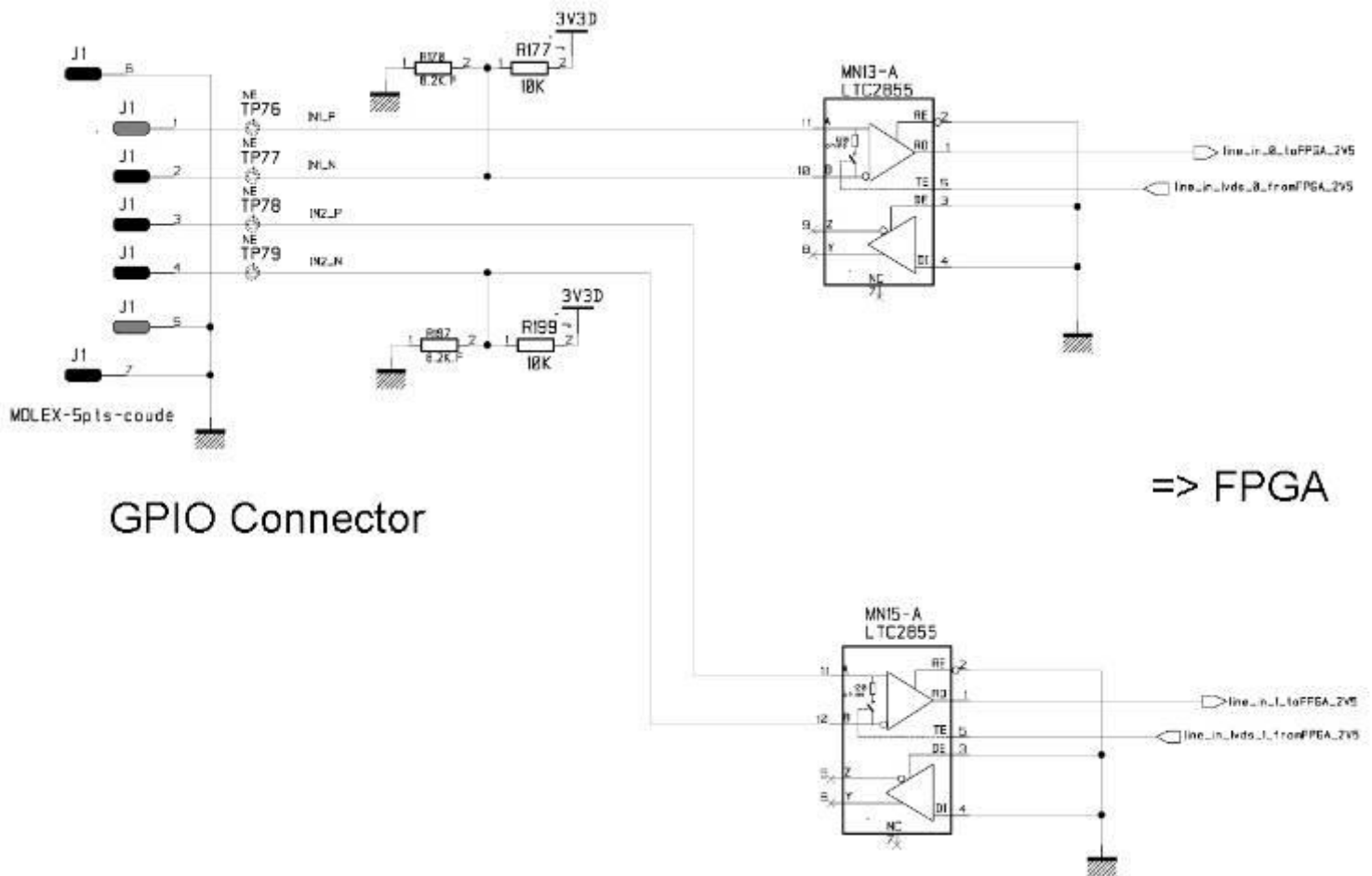

Standard Conformity

The ELIIXA+ cameras have been tested using the following equipment:

- A shielded Trigger cable
- A 10m CoaXPress Cable for the data transfer, certified at 6Gb/s

e2v recommends using the same configuration to ensure the compliance with the following standards.

CE Conformity

The ELIIXA+ cameras comply with the requirements of the EMC (European) directive 89/336/CEE (EN50081-2, EN 61000-6-2).

FCC Conformity

The ELIIXA+ cameras further comply with Part 15 of the FCC rules, which states that: Operation is subject to the following two conditions:

- This device may not cause harmful interference, and
- This device must accept any interference received, including interference that may cause undesired operation

This equipment has been tested and found to comply with the limits for Class A digital device, pursuant to part 15 of the FCC rules. These limits are designed to provide reasonable protection against harmful interference when the equipment is operated in a commercial environment. This equipment generates, uses and can radiate radio frequency energy and, if not installed and used in accordance with the instruction manual, may cause harmful interference to radio communications. Operation of this equipment in a residential area is likely to cause harmful interference in which case the user will be required to correct the interference at his own expense.

Warning: Changes or modifications to this unit not expressly approved by the party responsible for compliance could void the user's authority to operate this equipment.

Lenses Compatibility

QIOPTICS (LINOS)				
	Nominal Magnification	Magnification Range	M95 Focus tube Reference	Lens Reference Part number
Inspec.x. L 5.6/105	0,33 X	0,25 – 0,45 X	2408-012-000-41	0703-085-000-20
Inspec.x. L 5.6/105	0,5 X	0,4 – 0,65 X	2408-012-000-41	0703-084-000-20
Inspec.x. L 5.6/105	0,87 X	0,6 – 0,9 X	2408-012-000-43	0703-083-000-20
Inspec.x. L 5.6/105	1 X	0,85 – 1,2 X	2408-012-000-43	0703-082-000-20
Inspec.x. L 4/105	3 X	2,8 – 3,3 X	2408-012-000-46	0703-104-000-20
Inspec.x. L 4/105	3,5 X	3,3 – 3,7 X	2408-012-000-44	0703-095-000-21
Inspec.x. L 3.5/105	5 X	4,8 – 5,2 X	2408-012-000-45	0703-102-000-20
SCHNEIDER KREUZNACH				
	Nominal Magnification	Magnification Range	Working Distance (at nom. Mag.)	Reference Part number
SR 5.6/120-0058	1 X	0,88 – 1,13 X	212 mm	1002647
SR 5.6/120-0059	0,75 X	0,63 – 0,88 X	252 mm	1002648
SR 5.6/120-0060	0,5 X	0,38 – 0,63 X	333 mm	1002650
SR 5.6/120-0061	0,33 X	0,26 – 0,38 X	453 mm	1004611
Accessories	V mount 25mm macro-extension tube		Necessary to combine the whole lens system	20179
	V mount to Leica adapter			20054
	Unifoc 76			13048
	Adapter M58x0.75 – M95x1			1062891
	Extension tube M95x1, 25mm		To be combined to reach the appropriate magnification	1062892
	Extension tube M95x1, 50mm			1062893
	Extension tube M95x1, 100mm			1062894
MYUTRON				
	Nominal Magnification	Working Distance	M95 Custom Mount available Aperture (∞) : 4.7	
XLS03-E	x0,3	477mm		
XLS53-E	x0,5	324mm		
XLS75-E	x0,75	246mm		
XLS010-E	x1	197mm		
XLS014-E	x1,4	170mm		
XLS203-E	x2	146mm		
EDMUND OPTICS				
	Nominal Magnification	Working Distance (at nom. Mag.)	Reference Part number	
TechSpec F4	1 X	151 mm	NT68-222	
TechSpec F4	1,33 X	158,5 mm	NT68-223	
TechSpec F4	2,0 X	129 mm	NT68-224	
TechSpec F4	3,0 X	110 mm	NT68-225	
Accessories	Large Format Tip/Tilt Bolt Pattern Adapter, 2X		NT69-235	
	Large Format Focusing Module		NT69-240	
	Large Format Adapter Set		NT69-241	
NIKON				
Rayfact F4	0,05 X – 0,5 X	1820,4mm – 230,3mm	Rayfact ML90mm F4	

Frame Grabbers Compliance

Brand	F.G. Name	Detailed Reference	tested
Active Silicon	Firebird FBD-4XCXP6 in PCIe x8 (Gen2)	Software V1.2.0	OK
Aval Data	APX-3664	-	By AvalData
Bitflow	Cyton-CXP4	-	OK
Matrox	Radiant eV-CXP	MIL9 + Update 50 Build60	OK
Silicon Software	MicroEnable 5 AQ8-CXP6B	Software V5.3.8	OK

Models

Part Number	Definition / Max Speed	Details
EV71YC4CCP1605-BA0	16k/47.5kHz – 8k/95kHz	New Sensor Generation with Model Name ELIIXA2C4CCP1605