

Piranha XL™ XDR

eXtended Dynamic Range

PX-HM-16K06X-00-R and PX-HM-16K12X-00-R

sensors | **cameras** | frame grabbers | processors | software | vision solutions



03-032-20230-02
www.teledynedalsa.com

CAMERA
LinkHS™



TELEDYNE DALSA
Everywhereyoulook™

Notice

© 2017 Teledyne DALSA

All information provided in this manual is believed to be accurate and reliable. No responsibility is assumed by Teledyne DALSA for its use. Teledyne DALSA reserves the right to make changes to this information without notice. Reproduction of this manual in whole or in part, by any means, is prohibited without prior permission having been obtained from Teledyne DALSA.

Microsoft and Windows are registered trademarks of Microsoft Corporation in the United States and other countries. Windows, Windows 7, Windows 8 are trademarks of Microsoft Corporation.

All other trademarks or intellectual property mentioned herein belong to their respective owners.

Document Date: December 15, 2017
Document Number: 03-032-20230-02

About Teledyne DALSA

Teledyne DALSA is an international high performance semiconductor and Electronics Company that designs, develops, manufactures, and markets digital imaging products and solutions, in addition to providing wafer foundry services.

Teledyne DALSA Digital Imaging offers the widest range of machine vision components in the world. From industry-leading image sensors through powerful and sophisticated cameras, frame grabbers, vision processors and software to easy-to-use vision appliances and custom vision modules.

Contact Teledyne DALSA

Teledyne DALSA is headquartered in Waterloo, Ontario, Canada. We have sales offices in the USA, Europe and Asia, plus a worldwide network of representatives and agents to serve you efficiently. Contact information for sales and support inquiries, plus links to maps and directions to our offices, can be found here:

Sales Offices: <http://www.teledynedalsa.com/corp/contact/offices/>

Technical Support: <http://www.teledynedalsa.com/imaging/support/>

*****THIS IS AN UNCONTROLLED COPY OF A CONTROLLED DOCUMENT*****

The information contained herein is proprietary to Teledyne DALSA and is to be used solely for the purpose for which it is supplied.

It shall not be disclosed in whole or in part, to any other party, without the express permission in writing by Teledyne DALSA

Contents

THE PIRANHA XL XDR CAMERA	4
DESCRIPTION	4
CAMERA HIGHLIGHTS	5
<i>Key Features</i>	5
<i>Programmability</i>	5
<i>Applications</i>	5
PART NUMBERS AND SOFTWARE REQUIREMENTS	6
PERFORMANCE SPECIFICATIONS	6
<i>Certification & Compliance</i>	8
CAMERA PIXEL ARRANGEMENT	8
SUPPORTED INDUSTRY STANDARDS	9
<i>GenICam™</i>	9
<i>Camera Link HS</i>	9
<i>Camera Link HS Transmission Characteristics</i>	10
RESPONSIVITY & QE PLOTS	11
MECHANICAL DRAWINGS	13
PRECAUTIONS	14
<i>Electrostatic Discharge and the CMOS Sensor</i>	14
INSTALL & CONFIGURE FRAME GRABBER & SOFTWARE	14
<i>Using Sopera CamExpert</i>	14
<i>CamExpert Panes</i>	15
SETTING UP FOR IMAGING	18
<i>Powering the Camera</i>	18
<i>Data Cables</i>	19
<i>Lens Selection & Setup</i>	19
<i>Establishing Camera Communications</i>	20
<i>Establishing Data Integrity</i>	21
<i>Review of Camera Performance and Features</i>	21
SYNCHRONIZING TO OBJECT MOTION	21
<i>External Trigger Mode</i>	21
<i>Seamless Stop and Start Imaging</i>	22
<i>Internal Trigger Mode</i>	22
<i>Measuring Line Rate</i>	22
<i>Maximum Trigger (Line) Rate</i>	23
<i>Scan Direction</i>	23
<i>Camera Orientation</i>	25
ESTABLISHING THE DESIRED RESPONSE	26
<i>Exposure Control</i>	26
<i>Measuring Exposure Time</i>	27
<i>Adjusting Responsivity</i>	27
<i>Image Response Uniformity</i>	28
<i>Achieving the Best Image Stability</i>	29
<i>Adjusting Flat Field or Dark Calibration by Region*</i>	29
<i>Saving & Rapid Loading a PRNU Set Only</i>	30
<i>Setting Custom Flat Field Coefficients</i>	31
<i>Flat Field Calibration Filter</i>	31
<i>Flat Field Calibration Region of Interest</i>	31

<i>Selecting 16,352 or 16,384 Active Pixels of Image Data*</i>	31
ACHIEVING FASTER SCAN SPEEDS WHEN LOWER IMAGE RESOLUTION IS ACCEPTABLE (BINNING)	32
<i>Using Area of Interest to Reduce Image Data & Enhance Performance</i>	33
<i>Steps to Setup Area of Interest</i>	33
<i>The Rules for Setting Areas of Interest</i>	34
INCREASING DYNAMIC RANGE (LUT)	35
CONTRAST ENHANCEMENT	35
HELP WITH LENS FOCUSING & CAMERA ALIGNMENT	36
<i>Establish Optimum focus</i>	36
<i>Ensuring Rows are Aligned to the Object Motion</i>	36
CHANGING OUTPUT CONFIGURATION	39
<i>Bit Resolution</i>	39
<i>Camera Link HS Lane Selection</i>	39
<i>Using Two CLHS Cables</i>	39
<i>Using Fiber Modules</i>	40
SAVING & RESTORING CAMERA SETUP CONFIGURATIONS	40
<i>Active Settings for Current Operation</i>	41
<i>User Setting</i>	41
<i>Factory Settings</i>	41
<i>Default Setting</i>	42
APPENDIX A: GENICAM COMMANDS	43
<i>Camera Information Category</i>	43
<i>Camera Information Feature Descriptions</i>	44
<i>Built-In Self-Test Codes (BIST)</i>	47
<i>Camera Power-Up Configuration Selection Dialog</i>	47
<i>Camera Power-up Configuration</i>	47
<i>User Set Configuration Management</i>	47
<i>Camera Control Category</i>	47
<i>Camera Control Feature Descriptions</i>	48
<i>Digital I / O Control Feature Descriptions</i>	49
<i>Flat Field Category</i>	50
<i>Flat Field Control Feature Description</i>	51
<i>Image Format Control Category</i>	54
<i>Image Format Control Feature Description</i>	54
<i>Transport Layer Control Category</i>	56
<i>Transport Layer Feature Descriptions</i>	56
<i>Acquisition and Transfer Control Category</i>	58
<i>Acquisition and Transfer Control Feature Descriptions</i>	58
<i>File Access Control Category</i>	58
<i>File Access Control Feature Descriptions</i>	59
<i>File Access via the CamExpert Tool</i>	61
<i>Download a List of Camera Parameters</i>	61
APPENDIX B: TROUBLE SHOOTING GUIDE	62
<i>Diagnostic Tools</i>	62
<i>Camera Data File</i>	62
<i>Voltage & Temperature Measurement</i>	62
<i>Test Patterns – What can they indicate</i>	62
<i>Built-In Self-Test Codes</i>	62
<i>Status LED</i>	63
RESOLVING CAMERA ISSUES	64
<i>Communications</i>	64
<i>Image Quality Issues</i>	65
<i>Power Supply Issues</i>	71

<i>Causes for Overheating & Power Shut Down</i>	71
DECLARATION OF CONFORMITY	72
DOCUMENT REVISION HISTORY	73

The Piranha XL XDR Camera

Description

Teledyne DALSA introduces a breakthrough multiline CMOS TDI camera with unprecedented speed and responsiveness, and exceptional low noise. The Piranha XL™ camera has 16k pixel resolution and a 5 µm x 5 µm pixel size and is compatible with fast, high magnification lenses. The camera has a 125 kHz line rate, very low noise and high sensitivity through TDI on-chip summing of multiple image lines. Exposure control can be used for seamless variable speed imaging down to stopped conditions.

The Piranha XL camera uses the Camera Link HS™ interface, which is the industry standard for very high speed camera interfaces with long transmission distances and cable flexing requirements. Teledyne DALSA's Piranha XL camera and XTium Camera Link HS frame grabber combine to offer a complete solution for the next generation of Automatic Optical Inspection systems.

The Piranha XL camera is recommended for detecting small defects at high speeds and over a large field of view in LCD and OLED flat panel displays, printed circuit boards, film and large format web materials.

Three Piranha XL Models are Available

eXtended Dynamic Range Models (XDR)
The PX-HM-16K12X-00-R camera offers extended dynamic range and high scanning speed for applications detecting defects in very dark and very bright areas.
The PX-HM-16K06X-00-R camera offers extended dynamic range for applications targeted at highly variable scanning speed including those that involve stop and start conditions.
High Gain Camera Model
The PX-HM-16K12B-00-R camera offers the highest gain and scanning speed for light starved applications detecting low contrast defects.
The performance and features of the High Gain camera are detailed in the user document <i>Piranha XL High Gain: 03-032-20216</i> .

Camera Highlights

Key Features

- Highly responsive multiline CMOS-TDI
- 16k pixel resolution
- Very low noise
- High dynamic LUT mode
- Bi-directionality with fixed optical center
- Binning
- Small form factor
- Low power
- Robust Camera Link HS interface
- Smart lens shading correction
- Seamless stop and start imaging (with the PX-HM-16K06X-00-R model)

Programmability

- Adjustable responsivity
- Multiple areas of interest for data reduction
- Region of interest for easy calibration of lens and shading correction
- Test patterns & diagnostics
- 8 or 12 bit output

Applications

- Flat-panel LCD and OLED display inspection
- Web inspection
- Printed circuit board inspection
- High throughput and high resolution applications

Part Numbers and Software Requirements

The camera is available in the following configurations:

Table 1: Camera Models Comparison

Part Number	Resolution	Maximum Line Rates	Pixel Size
PX-HM-16K06X-00-R	16352 pixels x 12 rows	60 kHz (8 rows) 50 kHz (12 rows)	5.0 μm x 5.0 μm
PX-HM-16K12X-00-R	16352 pixels x 12 rows	125 kHz (8 rows) 100 kHz (12 rows)	5.0 μm x 5.0 μm

Note 1: See Exposure time requirement page 21

Table 2: Software

Software	Product Number / Version Number
Camera firmware	Embedded within camera
GenICam™ support (XML camera description file)	Embedded within camera
Sapera LT, including CamExpert GUI application and GenICam for Camera Link imaging driver	Version 7.40 or higher

Performance Specifications

Table 3: Camera Performance Specifications

Specifications	Performance	
Imager Format	High speed CMOS multiline scan	
Resolution	16352 Active Pixels x 8 and 12 rows ²	
PX-HM-16K06X-00-R	16352 Active Pixels x 8 and 12 rows ²	
PX-HM-16K12X-00-R	16352 Active Pixels x 8 and 12 rows ²	
Pixel Size	5.0 μm x 5.0 μm	
Pixel Fill Factor	100%	
Line Rate	PX-HM-16K12X-00-R	PX-HM-16K06X-00-R
	14 kHz ¹ to 125 kHz (8 rows)	0 to 60 kHz (8 rows)
	14 kHz ¹ to 100 kHz (12 rows)	0 to 50 kHz (12 rows)
Exposure Time	2 μs to 3 ms	
Bit Depth	8 and 12 bit, selectable	
Connectors and Mechanicals		
Control & Data Interface	Camera Link HS	
Power Connector	Hirose 6-pin male circular	
Power Supply	+ 12 V to + 24 V DC (with tolerance limits of +11.4 V to +25.2 V)	
Typical Power Dissipation	23 W *	
Size	97 mm (W) x 97 mm (H) x 61 mm (D)	
Mass	685 grams	
Operating Temp	+0 °C to +60°C, front plate temperature	
Optical Interface		

Lens Mount	M90x 1 mm
Sensor to Camera Front Distance	12 mm
Sensor Alignment (aligned to sides of camera)	
\ominus y (parallelism) x y z \ominus z	100 μ m \pm 100 μ m \pm 100 μ m \pm 250 μ m \pm 0.2°
Compliance	
Regulatory	CE, FCC, and RoHS
Communications Standards	GenICam, Camera Link HS

Note 1: The camera will operate below 14 kHz when using an external trigger but show global and pixel based increases in offset.

* Under adverse conditions and while operating at a maximum line rate and at the maximum temperature some cameras may experience a power dissipation of 25 W.

Operating Ranges	Performance		Notes
	Eight Rows	Twelve Rows	
Random Noise PX-HM-16K06X-00-R PX-HM-16K12X-00-R	6.7 DN rms 6.7 DN rms	8.5 DN rms 8.5 DN rms	
Peak Responsivity PX-HM-16K06X-00-R PX-HM-16K12X-00-R	800 DN/(nJ/cm ²) 800 DN/(nJ/cm ²)	1200 DN/(nJ/cm ²) 1200 DN/(nJ/cm ²)	@ 625 nm
Gain PX-HM-16K06X-00-R PX-HM-16K12X-00-R	1x to 2.5x 1x to 10x	0.67x to 2.5x 1x to 10x	Normal Range Extended Range
DC Offset	5 DN	5 DN	Can be adjusted as required 8 bit, 1x gain
Full Well PX-HM-16K06X-00-R PX-HM-16K12X-00-R	20,000e ⁻ 20,000e ⁻	28,000e ⁻ 28,000e ⁻	
PRNU	< \pm 2%	< \pm 2%	50% of calibration target
FPN	< \pm 2 DN	< \pm 2 DN	8 bit, 1x gain
SEE	2.8 nJ / cm ²	1.9 nJ / cm ²	
NEE PX-HM-16K06X-00-R PX-HM-16K12X-00-R	8.4 pJ /cm ² 8.4 pJ /cm ²	7.1 pJ /cm ² 7.1 pJ /cm ²	RN / Responsivity
Anti-blooming	> 100x Saturation	> 100x Saturation	
Integral non-linearity	< 2%	< 2%	

*DN = digital number

Test Conditions unless otherwise specified:

- Values measured using 12 bit, 1x gain

- 50 kHz line rate
- Light source: green LED 525 nm
- Front plate temperature: 45° C

Environmental Specifications	
Storage temperature range	-20 °C to +80 °C
Humidity (storage and operation)	15% to 85% relative, non-condensing
MTBF (mean time between failures)	> 100,000 hours, typical field operation

Certification & Compliance

Compliance
EN 55011, FCC Part 15, CISPR 11, and ICES-003 Class A Radiated Emissions Requirements
EN 55024 and EN 61326-1 Immunity to Disturbance
RoHS per EU Directive 2011/65/EC and WEEE per EU Directive 2002/96/EC and China Electronic Industry Standard SJ/T11364-2006

Camera Pixel Arrangement

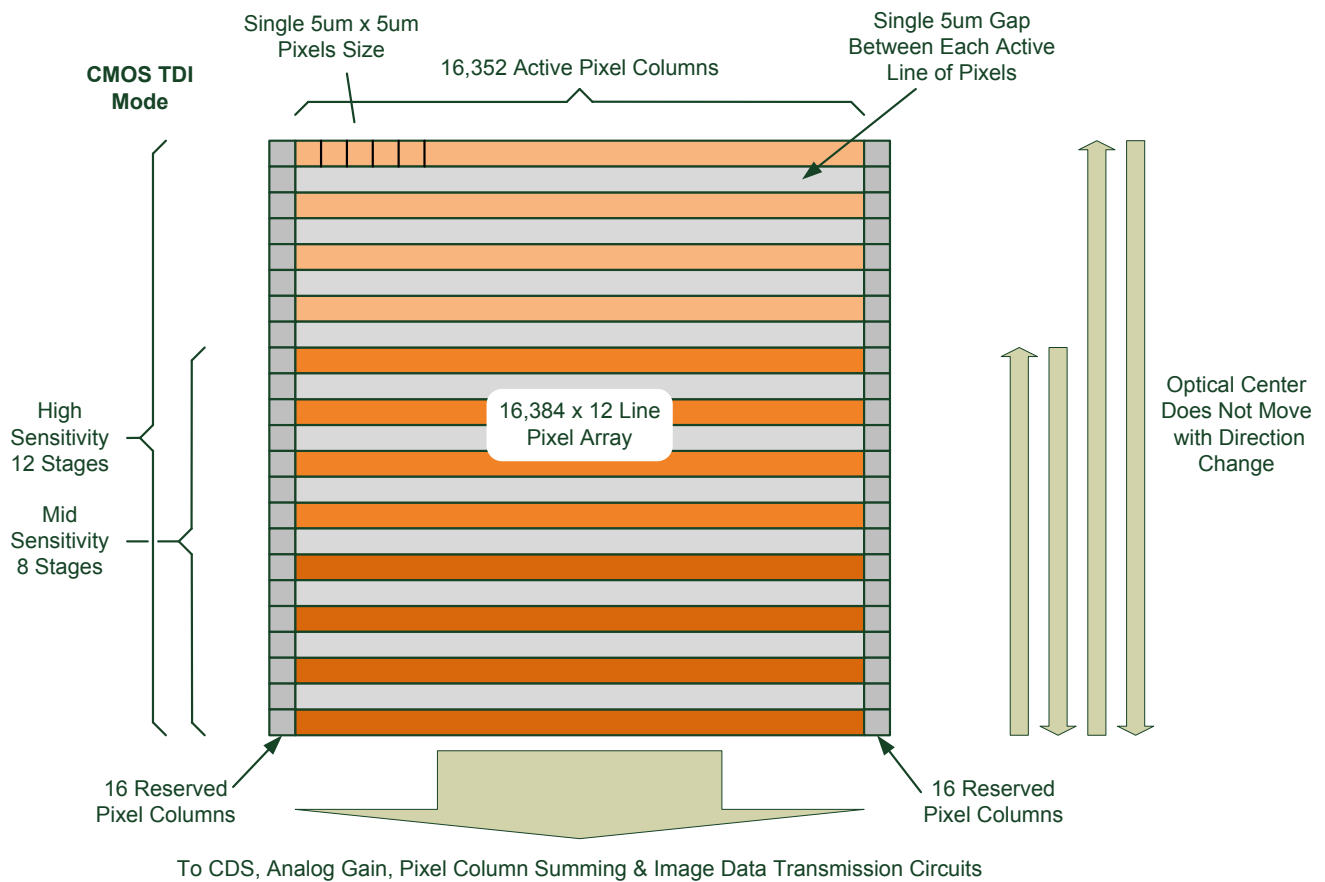

Figure 1: Camera CMOS-TDI Pixel Structure

The CMOS TDI sensor used in the camera is made up of a 16,384 x 12 line array of 5 µm x 5 µm pixels.

Each line of pixels is spaced 5 µm apart to accommodate pixel interface circuitry. 16 pixels at each edge of the array are reserved for special use by the camera, resulting in 16,352 pixels being available to the user. By default, 16,384 pixels are output by the camera where the 16 pixels at each edge are set to 1 DN. The Area of Interest feature (See section Using Area of Interest to Reduce Image Data & Enhance Performance) can be used to eliminate the 32 edge pixels if desired.

The 12 lines are grouped into three sets of four. The responsivity of the camera can be adjusted by summing 8 or 12 lines to form the output image data (See Adjusting Responsivity). Forward and reverse imaging does not cause the optical center to change. Exposure control allows inspection speed to change without changing responsivity from maximum speed down to the stopped condition.

Supported Industry Standards

GenICam™

The Piranha XL camera is GenICam compliant and implements a superset of the GenICam Standard Features Naming Convention specification V1.5.

This description takes the form of an XML device description file using the syntax defined by the GenApi module of the GenICam specification. The camera uses the GenICam Generic Control Protocol (GenCP V1.0) to communicate over the Camera Link HS command lane.

For more information see www.genicam.org.

Camera Link HS

The Piranha XL camera is Camera Link HS version 1.0 compliant. Camera Link HS is the next generation of high performance communications standards and is used where a digital industrial camera interfaces with single or multiple frame grabbers with data rates exceeding those supported by Camera Link. The Piranha XL camera includes two Camera Link HS compatible connectors, each capable of supporting data rates up to 2.1 Gbytes / sec per second. Each connector can also interface with standard 'CX4 Active Optical Cable' fiber modules where very long data transmission is required—up to 300 meters.

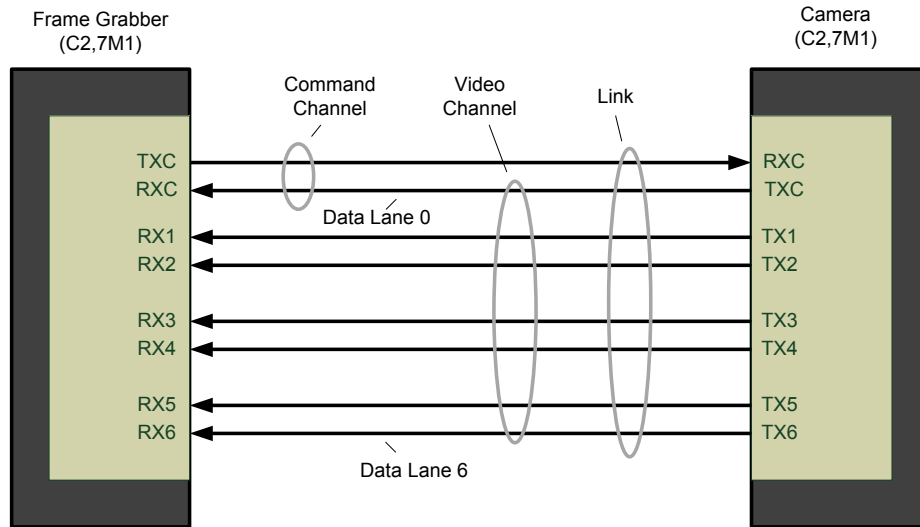

Figure 2. Single CLHS Connector Configuration

The command channel is used by the frame grabber to send command, configuration, and programming data to the camera and to receive command responses, status, and image data from the camera.

The designation C2,7M1 defines the use of a SFF-8470 connector (C2) and up to 7 lanes of data with 1 command channel using M-Protocol (8b/10b) at the default speed of 3.125Gb/sec.

When using a CX4 Active Optical Cable fiber module, only the command channel and data lanes 0, 1, 2 and 3 (C2,4M1) will be available, with an associated reduction in bandwidth. Use two fiber modules to retain the full performance of the camera.

The Piranha XL camera has two CLHS connectors that allow data to be routed to two separate frame grabbers installed in the same or separate PC's.

A feature of CLHS is that the initialization of the frame grabber automatically starts a discovery process that will identify the lane configuration of the camera. This process is transparent to the user and requires no action by the user to correctly configure the link.

Camera Link HS Transmission Characteristics

The camera's data distribution supports two cables with single CLHS ROI capability. The single CLHS ROI is determined from the 1 to 4 areas of interest (AOI) entered by the user and transmitted across all seven data lanes. There is a minimum of 96 pixels per data lane used.

CLHS limits the start and stop location of the ROI to a multiples of 32 pixels. The maximum line rate is limited by the sensor when not limited by the CLHS cable or by the PCIe transfer. The sensor is limited to a 125 kHz maximum line rate.

The CLHS cable has approximately 2.1 GByte / sec bandwidth for seven lanes. The XTIUM frame grabber has about 1.6 GByte / sec across the PCIe bus.

The Frame Grabber is able to store rows in order to perform a "burst-type" operation. CLHS packs the bits, while the frame grabber unpacks 12 bit data into 16 bit data across the PCIe bus. The table below shows a single cable with seven lane limits. When using 2 cables the performance is equivalent to using an 8k ROI and limited to the sensor's maximum data rates.

16K ROI		12K ROI		8K ROI	
Burst	Continuous	Burst	Continuous	Burst	Continuous
8 bit					
125,000	97,600	125,000	125,000	125,000	125,000
12 bit					
86,000	48,800	114,000	65,000	125,000	97,000

Responsivity & QE Plots

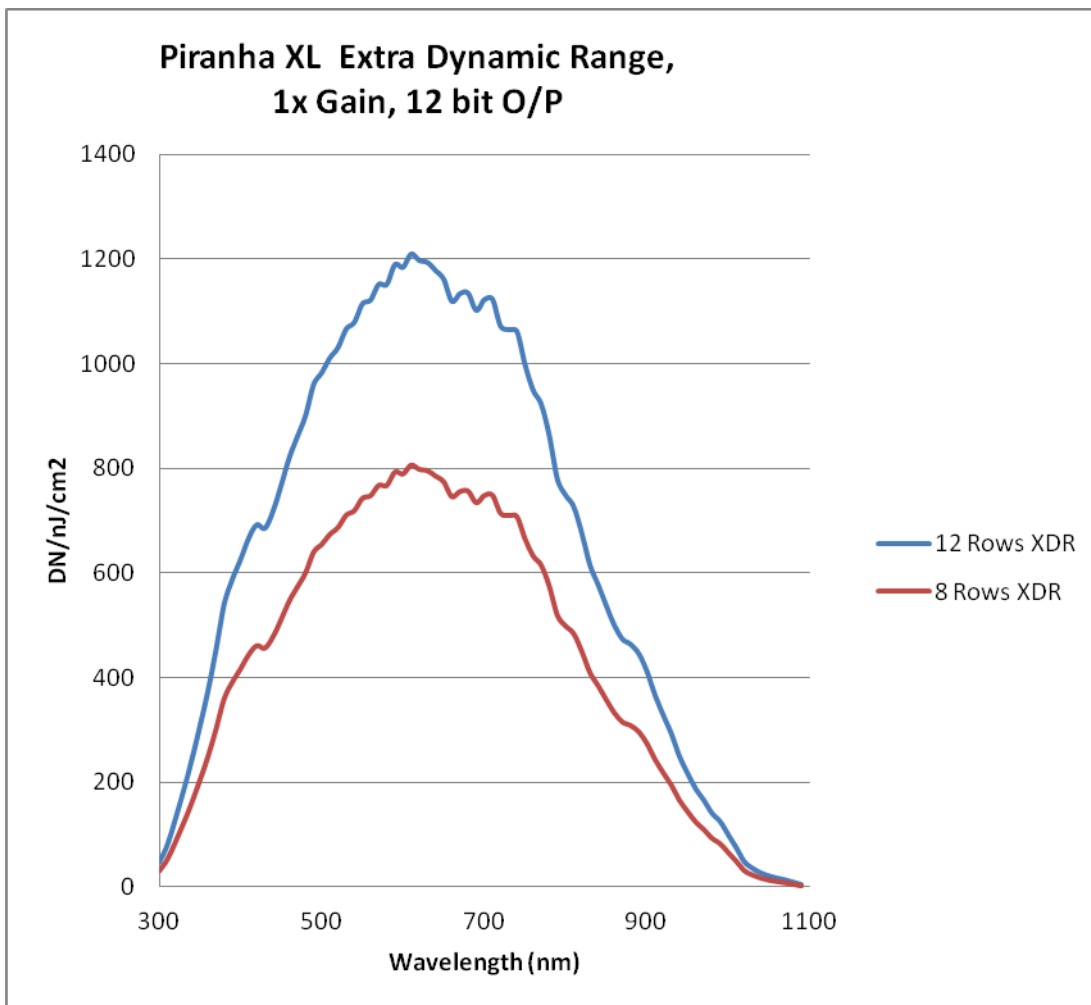

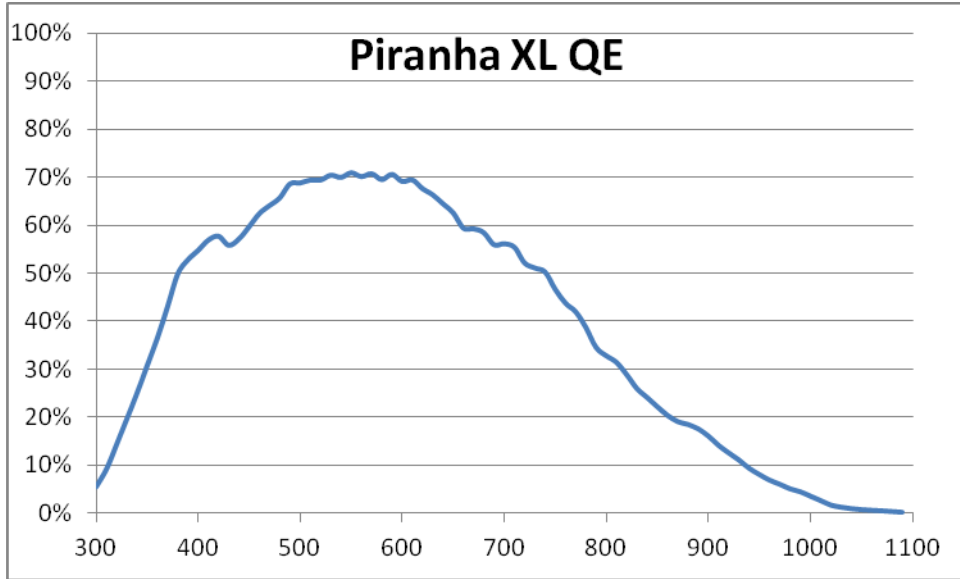

Mechanical Drawings

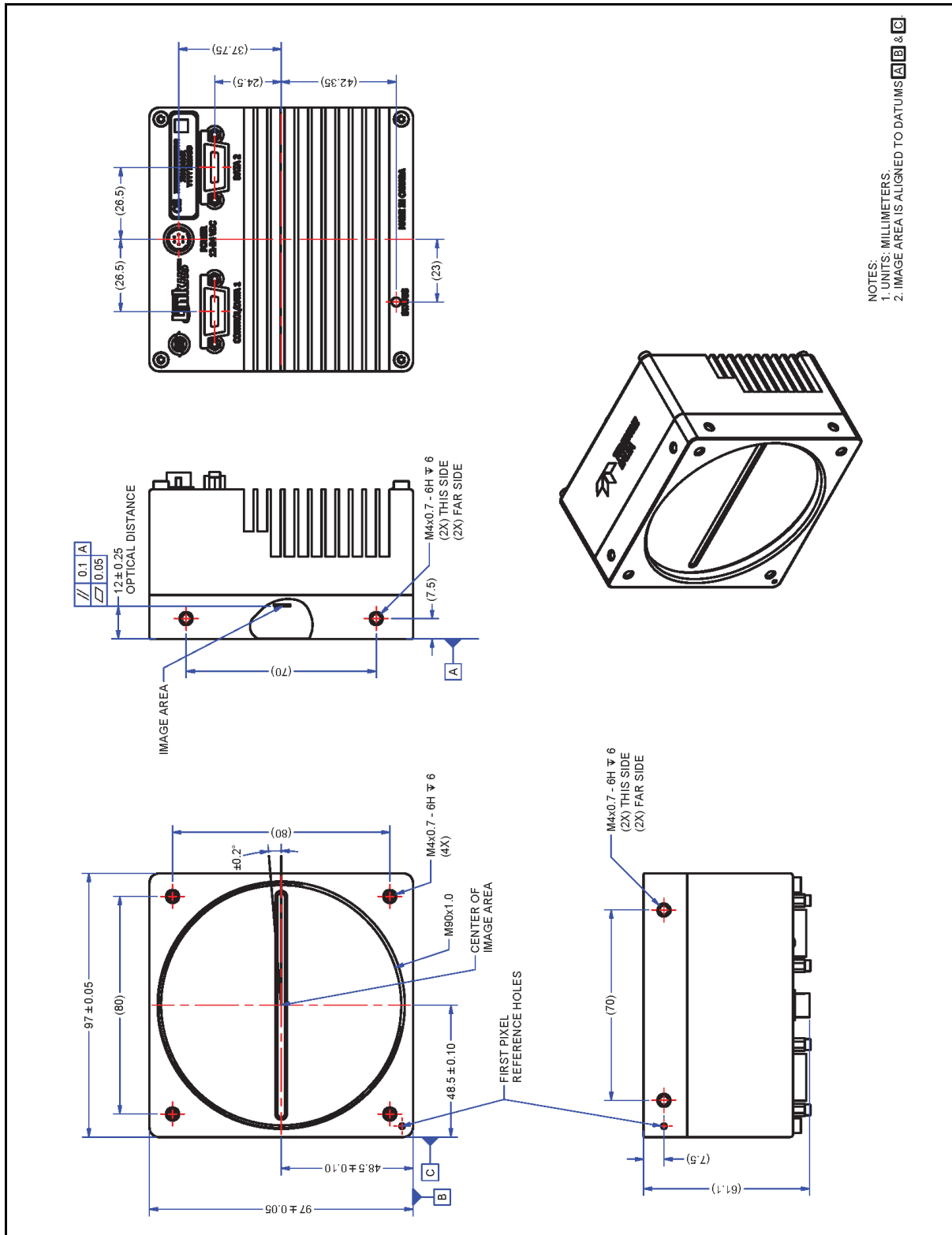

Precautions

Read these precautions carefully before using the camera.

Confirm that the camera's packaging is undamaged before opening it. If the packaging is damaged please contact the related logistics personnel.

Do not open the housing of the camera. The warranty is voided if the housing is opened.

Keep the camera's front plate temperature in a range of 0 °C to 60 °C during operation. The camera has the ability to measure its internal temperature. Use this feature to record the internal temperature of the camera when it is mounted in your system and operating under the worst case conditions. The camera will stop outputting data if its internal temperature reaches 80 °C. Refer to section 0 for more information on the 'Temperature' feature.

Do not operate the camera in the vicinity of strong electromagnetic fields. In addition, avoid electrostatic discharging, violent vibration, and excess moisture.

To clean the device, avoid electrostatic charging by using a dry, clean absorbent cotton cloth dampened with a small quantity of pure alcohol. Do not use methylated alcohol. To clean the surface of the camera housing, use a soft, dry cloth. To remove severe stains use a soft cloth dampened with a small quantity of neutral detergent and then wipe dry. Do not use volatile solvents such as benzene and thinners, as they can damage the surface finish. Further cleaning instructions are below.

Though this camera supports hot plugging, it is recommended that you power down and disconnect power to the camera before you add or replace system components.

Electrostatic Discharge and the CMOS Sensor

Image sensors and the camera's housing can be susceptible to damage from severe electrostatic discharge (ESD). Electrostatic charge introduced to the sensor window surface can induce charge buildup on the underside of the window. The charge normally dissipates within 24 hours and the sensor returns to normal operation.

Install & Configure Frame Grabber & Software

We recommend the Teledyne DALSA XTIUM frame grabber or equivalent, described in detail on the teledynedalsa.com site [here](#). Follow the manufacturer's installation instructions.

A GenICam compliant XML device description file is embedded within the camera firmware allowing for GenICam compliant applications to recognize the camera's capabilities immediately after connection. Installing Sopera LT gives you access to the CamExpert GUI, a GenICam compliant application.

Using Sopera CamExpert

CamExpert is the camera interfacing tool supported by the Sopera library. When used with a Piranha XL camera, CamExpert allows a user to test all camera operating modes. In addition, CamExpert can be used to save the camera's user settings configurations to the camera. Or saves multiple configurations as individual camera parameter files on the host system (*.ccf). CamExpert can also be used to upgrade the camera's software.

An important component of CamExpert is its live acquisition display window. This window allows the user to immediately verify the timing or control parameters without needing to run a separate acquisition program.

To control the camera and frame grabber settings, the user must open two instances of CamExpert—one is used to control the frame grabber features and as a display window. The second instance is used to control the camera features.

For context sensitive help, click on the  button and then click on a camera configuration parameter.

A short description of the configuration parameter will be shown in a popup. Click on the  button to open the help file for more descriptive information on CamExpert.

The central section of CamExpert provides access to the camera features and parameters. **Note:** The availability of features depends on the CamExpert user setting. Not all features are available to all users.

A note on the CamExpert examples shown here: The examples shown for illustrative purposes and may not entirely reflect the features and parameters available from the camera model used in your application.

CamExpert Panes

CamExpert, first instance: select Camera Link HS Mono using the Device drop-down menu.

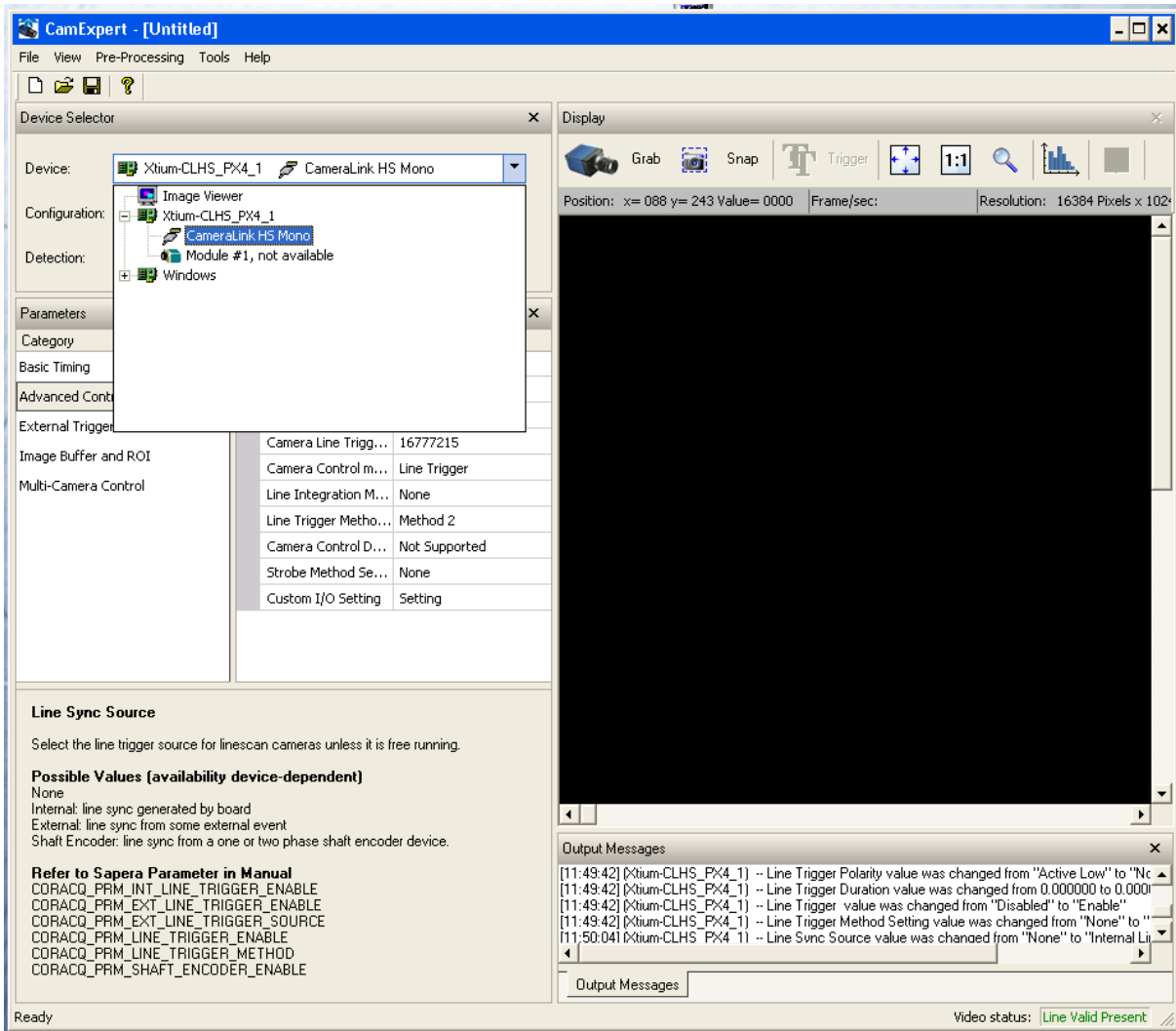

Figure 3. CamExpert Frame Grabber Control Window

CamExpert, second instance: select PX_HM_16k12B_00_R using the Device drop-down menu.

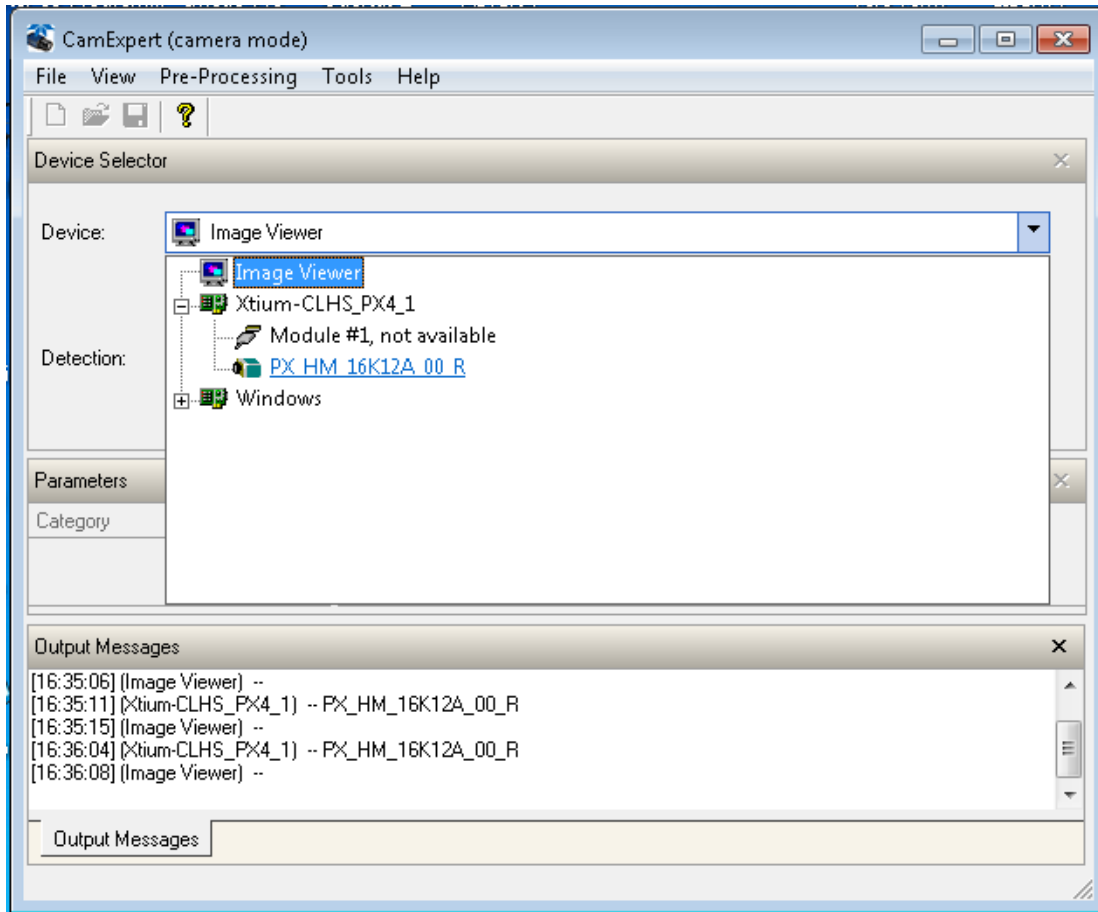

Figure 4. CamExpert Camera Control Window



The CamExpert application uses panes to organize the selecting and configuring of camera files or acquisition parameters.



Device Selector pane: View and select from any installed Sapera acquisition device. Once a device is selected, CamExpert will only show acquisition parameters related to that device. Optionally, select a camera file included with the Sapera installation or saved by the user.

Parameters pane: Allows the viewing or changing of all acquisition parameters supported by the acquisition device. CamExpert displays parameters only if those parameters are supported by the installed device. This avoids confusion by eliminating parameter choices when they do not apply to the hardware in use.

Display pane: Provides a live or single frame acquisition display. Frame buffer parameters are shown in an information bar above the image window.

Control Buttons: The Display pane includes CamExpert control buttons. These are:

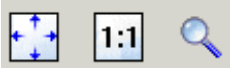
 Grab	 Freeze	<p>Acquisition control button: Click once to start live grab, click again to stop.</p>
 Snap	<p>Single frame grab: Click to acquire one frame from device.</p>	

 Trigger	Trigger button: With the I/ O control parameters set to Trigger Enabled, click to send a single trigger command.
	CamExpert display controls: (these do not modify the frame buffer data) Stretch image to fit, set image display to original size, or zoom the image to virtually any size and ratio.
	Histogram / Profile tool: Select to view a histogram or line/ column profile during live acquisition or in a still image.

Output Message pane: Displays messages from CamExpert or the device driver. At this point you are ready to start operating the camera in order to acquire images, set camera functions, and save settings.

Setting Up for Imaging

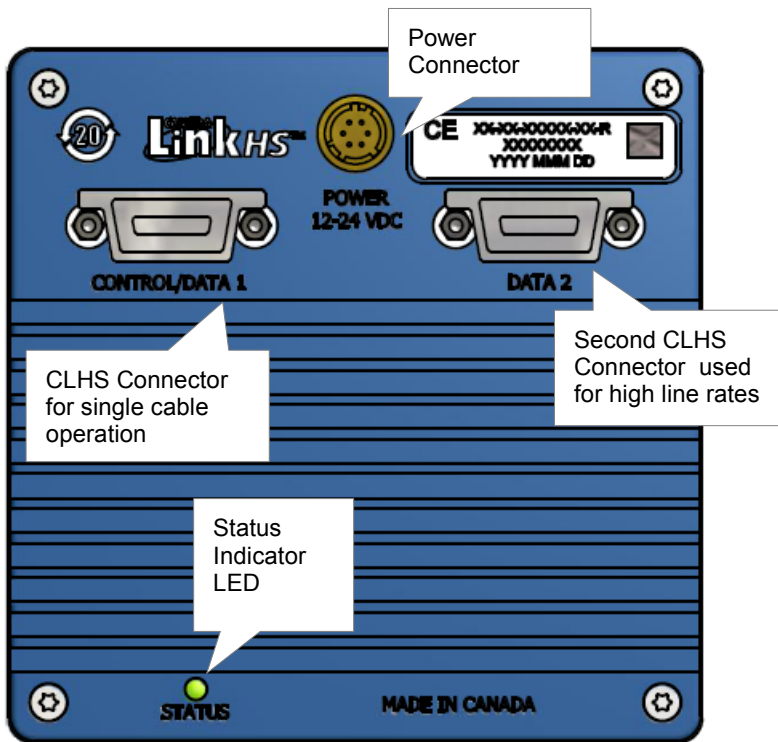

Powering the Camera

WARNING: When setting up the camera's power supply follow these guidelines:

- Apply the appropriate voltages of between +12 Volt to +24 Volt. Incorrect voltages may damage the camera.
- Before connecting power to the camera, test all power supplies.
- Protect the camera with a 3 amp slow-blow fuse between the power supply and the camera.
- Do not use the shield on a multi-conductor cable for ground.
- Keep leads as short as possible in order to reduce voltage drop.

- Use high-quality supplies in order to minimize noise.
- When using a 12 Volt supply, voltage loss in the power cables will be greater due to the higher current. Use the Camera Information category to refresh and read the camera's input voltage measurement. Adjust the supply to ensure that it reads above or equal to 12 V.

Note: If your power supply does not meet these requirements, then the camera performance specifications are not guaranteed.

The camera uses a Hirose 6-pin female connector for power. The Hirose male connector is part# HR10A-7P-6S and should have the following pin out.

Hirose 6-pin Circular Male



Mating Part: HIROSE
HR10A-7P-6S

Table 4. Power Plug Pin Out

Pin	Description	Pin	Description
1	+12 V to +24 V DC	4	GND
2	+12 V to +24 V DC	5	GND
3	+12 V to +24 V DC	6	GND

The power cable wire gauge should be sufficient to accommodate a power-up surge of at least 3 amps with a minimum voltage drop between the power supply and camera. The camera can accept **any** voltage between 12 Volts and 24 Volts. If there is a voltage drop between the power supply and camera, ensure that the power supply voltage is at least 12 Volts plus this voltage drop. The camera input supply voltage can be read using CamExpert. Refer to the section Voltage & Temperature Measurement for details.

Data Cables

The Camera Link HS cables are made to handle very high data rates. Cable length can be up to 15 meters. Camera Link HS cables can be bought from an OEM. OEM cables are also available for applications where flexing is present. Please see Teledyne DALSA's website (www.teledynedalsa.com) for a list of qualified vendors and part numbers.

If you want to fabricate your own cables, please refer to the Camera Link HS Specification Version 1.0 for printout details and design guidelines. Each data cable is used for sending image data to and accepting command data from the frame grabber. Command data includes GenICam compliant messages, trigger timing, and general purpose I / O, such as direction control.

Lens Selection & Setup

To ensure optimum optical performance for all 16k pixels, the lens image circle must be greater than 82 mm. This typically means using at least an 80 mm focal length lens. And longer focal length lenses may be required to achieve the minimum image circle requirement. Another significant consideration in selecting an appropriate lens is to ensure acceptable MTF performance over the entire sensor length. Also, this should be matched to the sensor pixel size of 5 μm x 5 μm . Lens and barrel edge roll off (vignetting) is another performance factor of the lens and is an element in determining the brightness variation between center and edge pixels. Further, ensure that the extension tube inner walls do not obstruct any part of the lens aperture with respect to the

sensor. Illumination beam structure can also affect edge roll off. The more diffuse the light, the less edge roll off.

We recommend that the user talk to their lens provider for detailed help in selecting a suitable lens for the application and detailed lens setup design guidelines.

- Before starting to image, take the following steps to set up the lens to a state close to being focused:
- In the lens specification, find the distance from the lens mounting flange surface to its principle plane.
- Determine the magnification for your application = sensor pixel size (5 μm) / object pixel size in μm .
- Use the lens specification to find the actual lens focal length, F. Often this value varies slightly from the one advertised.
- Calculate the distance from the front face of the camera to the lens flange using the following formula:
- Camera Face to Flange = $F (1 + 1 / m) - 12 \text{ mm} - \text{Principle Plane to Flange (From lens spec.)}$
- With the focusing helical in the center of its range, assemble your extension tubes such that their total length equals the Camera Face to Flange distance.
- Install the lens on the focusing helical and the lens assembly on to the camera.
- Calculate the distance from the object surface you intend to image to the front face of the camera using the following formula:
- Object Surface to Camera Face = $F \times (2 + m + 1 / m) + \text{HH}' - 12 \text{ mm}$
- (Note: HH' is the distance between the two principle planes of the lens. You can get this from the lens specifications.)
- Adjust the camera squarely to the object surface with the Object Surface to Camera Face distance equal to the value determined above.
- The lens setup should now be good enough to use during camera evaluation. Fine adjustment of the focusing helical should be all that is required to get the image in focus at the desired magnification.

Establishing Camera Communications

Power up the camera and observe the LED which indicates the following status conditions:

LED State	Description
Off	Camera is not powered up or is waiting for the software to start.
Constant Red	The camera BIST status is not good. See BIST status for diagnosis. CamExpert can be used to get the BIST value from the camera.
Blinking Red	The camera has shut down due to a temperature problem.
Blinking Orange	Powering Up. The microprocessor is loading code.
Blinking Green	Hardware is good but the CLHS connection has not been established or has recently been broken.

Constant Green The CLHS Link has been established and data transfer may begin.

When the camera status indicator LED state is a constant green, the camera is ready to start the first instance of CamExpert.

1. CamExpert will search for installed Sopera devices.
2. In the Devices list area on the left side of the window, the connected frame grabber will be shown.

3. Select the frame grabber device by clicking on the name

Start the second instance of CamExpert.

1. CamExpert will again search for any installed Sopera devices.
2. In the Devices list area on the left side, the connected camera will be shown.
3. Select the camera device by clicking on the name.
4. The XML is automatically read from the camera and CamExpert will use it to set up the panes detailing the configurable functionality of the camera.

The two CamExpert instances can now be used to set up the camera and frame grabber for capturing the first images. See Appendix 0 for a detailed description of the camera features available in each pane.

Establishing Data Integrity

- Use the camera's internal Triggering. This will allow initial imaging with a static object and no encoder input will be required.
- Enable the camera to output a test pattern.
- Use a frame grabber CamExpert instance to capture, display, and analyze the test pattern image to verify the integrity of the connection. If the test pattern is not correct, check the cable connections and the frame grabber setup.
- Disable the test pattern output.

Review of Camera Performance and Features

This section is intended to be a progressive introduction to the features of the Piranha XL camera and how to use them effectively.

Synchronizing to Object Motion

The Piranha XL camera supports two trigger modes: internal and external. Internal was used in the previous sections where synchronization to image motion was not required.

External Trigger Mode

See the section Digital I / O Control Feature Descriptions in Appendix A for GenICam features associated with this section and how to use them.

Relevant Feature: Trigger Source, Trigger Selector, Trigger Mode

The Piranha XL sensor uses a multi-line CMOS TDI technology where the image is integrated over multiple adjacent lines as it moves over the sensor. All the lines are then summed to achieve a highly responsive output. To achieve correct summing, it is vital that the image motion across the sensor is synchronized to the integration timing of the sensor. The user must provide a synchronizing external trigger pulse derived from an encoder that generates one pulse for one object pixel of motion. The encoder signal must be connected to the encoder input of the frame grabber. See the XTIUM frame grabber user manual ([here](#)) for details on how to make this connection.

CamExpert can be used to configure the frame grabber for routing the encoder signal from the frame grabber input to the trigger input of the camera via the Camera Link HS data cable.

The continuous stream of encoder trigger pulses synchronized to the object motion establishes the line rate. The faster the object's motion is, the higher the line rate. The Piranha XL camera can accommodate up to its specified maximum frequency. If the maximum frequency is exceeded, the camera will continue to output image data at the maximum specified. The result will be that some trigger pulses will be missed and there will be an associated distortion of the image data. When the line rate returns to below the maximum specified, then normal imaging will be reestablished.

Seamless Stop and Start Imaging

The Piranha XL camera can accommodate the full range of line rate frequencies—from the maximum specified to a stopped condition. No line artifact is generated as the line rate approaches and reaches the stopped condition and starts up again in the same direction (the PX-HM-16K06X-00-R model only). Care must be taken that at no time does the object go backwards, even for a single line, as it comes to a stop and starts up again. If a momentary backwards motion occurs when stopping and starting, the result may be a blurred image for a few lines.

Internal Trigger Mode

See the section Camera Control Category in Appendix A for GenICam features associated with this section and how to use them.

Relevant Feature: Internal Line Rate

The internal trigger mode does not have much use in the normal inspection system environment, as TDI imaging requires an accurate synchronization to the objects motion. However, the internal mode can be very useful when a stationary target is used for camera evaluation or debugging issues.

Measuring Line Rate

See Camera Control Category in Appendix A for GenICam features associated with this section and how to use them.

Relevant Feature: Measured Line Rate, Refresh Measured Line Rate

The camera has the means to measure the line (trigger) rate that is currently being applied to the trigger input of the camera, or what is being internally generated. This is not a continuous reading but a one-time measurement that needs to be initiated by the user with the *Refresh Measured Line Rate* command.

Maximum Trigger (Line) Rate

There are now two configurations of the Piranha XL camera.

- The high speed configuration PX-HM-16K12X-00-R has a useful operating range from 14 kHz up to 125 kHz. It will operate below 14 kHz but may experience increased offset associated with dark current, both on a pixel and global basis.
- The low speed configuration PX-HM-16K06X-00-R has a useful operating range from 0 kHz up to 60 kHz. It can achieve defect free stop and start imaging.

Maximum Line Rates for a 16k Pixel Image, Single Cable				
Row Configuration	PX-HM-16K12X-00-R		PX-HM-16K06X-00-R	
	8Bits	12 bits	8 Bits	12 Bits
4 Rows				
7 Lanes	125kHz	87kHz	60kHz	60kHz
4 lanes	74kHz	50kHz	60kHz	50kHz
1 Lane	18kHz	12kHz	18kHz	12kHz
8 Rows				
7 Lanes	125kHz	87kHz	60kHz	60kHz
4 lanes	74kHz	50kHz	60kHz	50kHz
1 Lane	18kHz	12kHz	18kHz	12kHz
12 Rows				
7 Lanes	100kHz	87kHz	50kHz	50kHz
4 lanes	74kHz	50kHz	50kHz	50kHz
1 Lane	18kHz	12kHz	18kHz	12kHz

Scan Direction

See the section Camera Control Category in Appendix A for GenICam features associated with this section and how to use them

Relevant Features: Direction Source, Internal Direction

The Piranha XL camera can accommodate a forward and reverse scan direction. The sensor timing must follow the image as it moves over its imaging area. If the direction is wrong then the image will look out of focus, as can be seen in the following figure.

Image scanned in direction where the TDI rows track the object motion

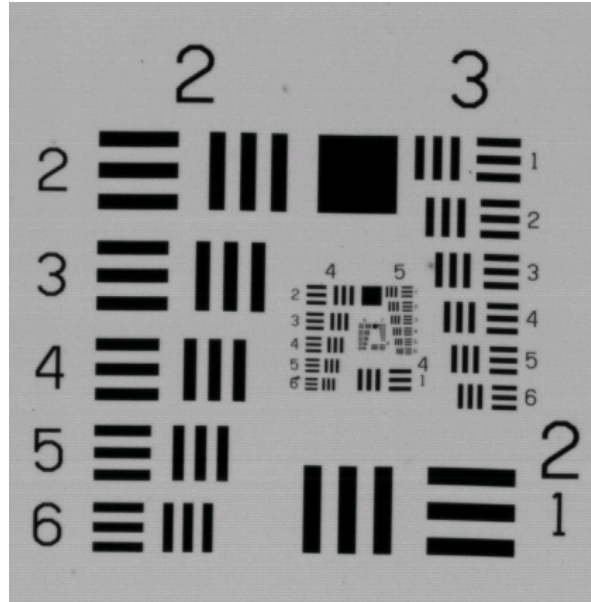

Figure 5. Image with proper scan direction

Image scanned in direction where the TDI rows track opposite to the object motion



Figure 6. Image with incorrect scan direction

Some AOI systems require the scan direction to change at regular intervals, such as those scanning a panel forwards, coming to a stop, and then scanning backward as the cameras field of view is progressively indexed over the entire panel. Direction can be dynamically controlled by sending the appropriate direction command to the camera or via the CLHS GPIO (General Purpose Input/Output) control bits.

It is important to note that when the camera line rate comes to a stop and the direction is changed the correct imaging will not be achieved for several scan lines. Therefore, it is necessary for the system to over-scan the area being imaged, including the lines that are not valid as a result of the direction change. This will ensure that valid data will be generated on the return path, as the

camera field of view reaches the area to be inspected. The number of invalid lines that result after the direction change are as follows:

Number of Rows	Number of Invalid Lines
4	7
8	15
12	23

The mechanical diagram shows which direction is designated as forward for the camera. However, due to the characteristics of the lens, the direction of the objects motion is opposite to the image motion direction.

Camera Orientation

The diagram below shows the definition of forward and reverse with respect to the camera body. Note that the diagram assumes the use of a lens which inverts the image.

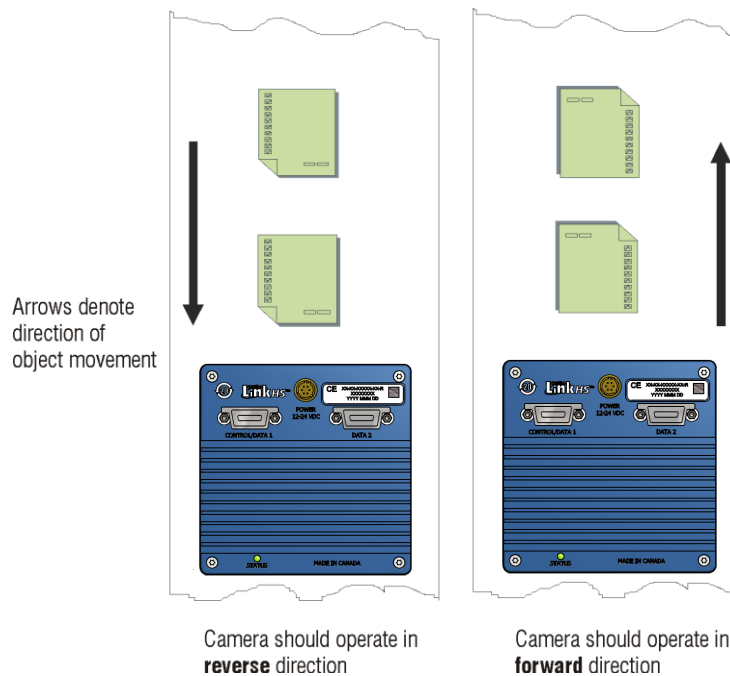

Figure 7: Object Movement and Camera Direction Example using a Lens

Establishing the Desired Response

One of the most important performance characteristics of the Piranha XL camera that will determine the camera's suitability for a specific application is its responsivity and the associated noise level at the system's maximum line rate and under the desired illumination conditions and lens configuration.

Responsivity and noise performance can be assessed using a stationary plain white bright target under bright field illumination; or by using no target for rear bright field illumination.

When evaluating the camera's responsivity and noise performance, it is important that the camera setup is representative of the system configuration. The setup should meet the following conditions:

- The camera is set up for TDI imaging.
- The lens is in focus, at the desired magnification, and with the desired aperture.
- The illumination intensity is equal to that of the Automatic Optical Inspection (AOI) system and is aligned with the camera field of view.
- The camera is operated with an exposure time that will allow the maximum line rate of the system to be achieved. The camera's internal line rate generator and exposure control can be used for a stationary target.

Exposure Control

See the section Camera Control Category in Appendix A for GenICam features associated with this section and how to use them.

Relevant Features: Exposure Time Source, Exposure Time Selector, Exposure Time

Exposure time determines how long pixels collect photons and accumulate the electrons generated. The longer the exposure time, the more electrons are accumulated and the greater increase in response.

The exposure time for each line captured is initiated by the trigger pulse and must be completed before the next trigger pulse occurs. The camera also requires enough time at the end of the exposure time in order to transfer the image out of the pixels for analog-to-digital conversion. Therefore, the exposure time cannot be longer than the period between trigger pulses at the highest line rate minus 2 μ sec for 8 and 12 rows.

The Piranha XL camera uses the GenCP Exposure Time feature as the only means to adjust exposure time. This ensures that the exposure time period is very stable with respect to the camera's internal timing. Any variation will become line noise in the image.

When using internal trigger mode, the camera will only accept an exposure time that can be accommodated within the internal line rate that has been set. When using external trigger mode, the user must ensure that the exposure time can be accommodated within the maximum line rate period minus 2 μ sec for 8 and 12 rows. If the exposure time is longer than the line rate period, then some of the trigger pulses will be ignored and the image will appear compressed in the scan direction.

When evaluating the responsivity of the camera, set the exposure time to the maximum allowable for the system, minus any margin required for illumination degradation, if applicable. The line rate

during evaluation is not critical and can be internal or externally triggered as long as its period does not violate the above rule.

Note that when adjusting the exposure time, a momentary loss of LVAL will occur. This will also happen when changing user sets that include exposure time. In addition, for each exposure time used an associated FPN and PRNU calibration should be performed and the results stored in a user set for recovery when the exposure time is selected.

Please note that it is important that customers using the PX-HM-16K12X-00-R model camera run the FPN and PRNU correction at a line rate above 14 kHz. Failing to do so may result in an unsatisfactory calibration that will result in an image with vertical streaking.

Measuring Exposure Time

See the section *Camera Control Category in Appendix A for GenICam features associated with this section and how to use them.*

Relevant Feature: Measured Exposure Time, Refresh Measured Exposure Time

The camera has the means to measure the exposure time that is currently being internally generated. This is not a continuous reading but a one-time measurement that needs to be initiated by the user through issuing a *Refresh Measured Exposure Time* command.

Adjusting Responsivity

See the section *Camera Control Category in Appendix A for GenICam features associated with this section and how to use them.*

Relevant Features: Row Selector, Gain Selector, Gain

It is desirable for camera performance to always use the maximum exposure time possible based on the maximum line rate of the inspection system and any margin that may be required to accommodate illumination degradation. However, it will be necessary to adjust the responsivity to achieve the desired output from the camera. The camera has a row selector feature and a gain feature that can be used to make the necessary adjustment to the responsivity.

Two row selections are available: 8 rows and 12 rows.

- 8 rows offer the highest responsivity at the highest line rate. It is optimized for light starved inspection systems where low contrast defects must be extracted from dark images and where the dark noise level needs to be minimized (i.e. minimizes Noise Equivalent Exposure).
- 12 rows are useful for light starved inspection systems but at a maximum line rate less than 8 rows. This may be useful for lower performance or cost sensitive systems where less intense, lower cost, illumination is used.

A single gain adjustment is used for any of the row configurations. Gain can be adjusted from 0.65x to 10x (Extended Gain Range Enabled), depending on the number of rows selected. Using row selection and gain adjustment the camera's responsivity can be changed by a factor of 15x— from lowest to highest responsivity performance.

When evaluating responsivity, it is best to start with eight rows and then move to twelve rows if the resulting responsivity does not meet your application's requirements.

Note that when adjusting the row selection, a momentary loss of LVAL will occur. This will also happen when changing user sets that include row selection.

Image Response Uniformity

See the section *Flat Field Category in Appendix A for GenICam features associated with this section and how to use them*

Relevant Features: Calibrate FPN, Calibrate PRNU, Calibration Algorithm, Calibration Target

It is common to find an image with lower response at the edges of the camera's field of view compared to its center. This is typically the result of a combination of lens vignetting ($\cos^{4\text{th}}$) roll-off and the beam structure of the illumination source. A more diffused light may reduce this roll-off effect. However, if decreasing the lens aperture improves the edge roll-off, then barrel vignetting (a shadow cast on the sensor by the focus helical or extension tubes) may also be present.

The camera can compensate for edge roll-off and other optical non-uniformities through flat field calibration.

- When performing Flat Field (PRNU) calibration, the camera should be imaging a front illuminated white target or rear bright field illumination source. The optical setup should be as per the inspection system, including lens magnification, aperture, and illumination intensity, plus illuminator beam structure.
- Flat field calibration should be performed for each row selection that will be used by the system and saved as a distinct user set (see the Saving & Restoring Camera Setup Configurations section). Whenever a different number of rows are selected the camera setup will default to the factory settings. The user must select and load the associated user set for the number of rows in use that was previously saved in the user set
- Flat field calibration should be performed when the camera temperature has stabilized.
- When the camera is commanded to execute a flat field calibration it will adjust all pixels to have the same value as that of the peak pixel value or target level, as per the calibration mode selected.
- If flat field calibration is being set to a target level that is lower than the peak value and the system gain is set to a low value, then it is possible that the sensor will maximize its output before the camera's output reaches 255 DN. This can be seen when a portion of the output stops increasing with increasing illumination and the PRNU deteriorates. This effect can be resolved by reducing the light level or exposure control time.

On completion of a flat field calibration, all pixels should be at their un-calibrated peak value or target value. Subsequent changes in gain allow the user to make refinements to the operating responsivity level.

Note that the best flat field calibration can be achieved by performing it at the mid DN level of the working range used in the operation. Any flat field error associated with residual non linearity in the pixel will be halved as compared to performing a calibration at the peak value of the operating range. A simple way of performing this is to reduce exposure time to half what is used in the operation in order to get the mid DN level for flat field calibration. Once complete, return the exposure time to its original setting.

Those areas of the image where high roll-off is present will show higher noise levels after flat field calibration due to the higher gain values of the correction coefficients. Flat field calibration can only compensate for up to an 8:1 variation. If the variation exceeds 8:1, then the line profile after calibration will include pixels that are below the un-calibrated peak level.

Achieving the Best Image Stability

See the section Flat Field Category in Appendix A for GenICam features associated with this section and how to use them

Relevant Features: Calibrate Black Level, Auto Black Enable

The camera design has been optimized to ensure that the image remains stable over a wide range of temperatures. For applications that require even better image consistency over temperature, a Calibrate Black Level feature is available. This function can be performed at any time, even when imaging a bright field, with illumination ON. A lens cap (dark field) is not required.

The user can take advantage of this feature during non-imaging times of the inspection process. For example, each time an inspected item or material is unloaded and a new item or material is loaded, ready for inspection. When a Calibrate Black Level is initiated, the camera requires two seconds to complete the operation.

If the inspection process has no non-imaging events over a long duration and the environment experiences large changes in temperature, an automatic black balancing calibration feature is available. When enabled, the camera automatically looks for opportunities to perform a black level balance calibration where image content is uniform. However, image uniformity may be slightly compromised where the image content has continuous rapid changes in contrast. For this algorithm to be most effective, a User FPN and PRNU calibration should be performed, saved, and then restored as appropriate to the current inspection environment.

When the camera powers up, it will default to the Auto Black Calibration ON mode, as this will be backwards compatible with the operation of earlier cameras.

Adjusting Flat Field or Dark Calibration by Region*

See the section Flat Field Category in Appendix A for GenICam features associated with this section and how to use them

Relevant features that adjust gain by region: ROI PRNU Multiplier, Multiply pixel PRNU coefficients in ROI, User PRNU Set Selector, Save User PRNU Set, Load User PRNU Set

Relevant Features that adjust dark level by region: SFR ROI Selector, SFR ROI Offset X, SFR ROI Width, SFR ROI Value

Some applications have bright and dark regions where a more even response is required. This can be achieved by adjusting the gain for each region, adjusting the dark offset, or a combination of the two.

Adjusting the gain will preserve relative contrast ratio. Adjusting the offset lower, which can include below zero, with gain or to bring the image out of saturation can be used to enhance relative contrast ratio.

Further, applications may also have several different lighting conditions with each requiring their own flat field coefficients and the means to quickly and easily switch between them. To this end, the following features are provided:

1. The ability to apply a multiplier on up to four regions of user Flat Field (PRNU) coefficients.
2. The ability to save and load user PRNU coefficients independent of a user set that contains all adjustable parameters.
3. The ability to adjust up to four regions of dark offset lower.

We recommend that before saving custom PRNU profiles you first save all the current camera settings using the Camera Information > Settings feature. The Save User PRNU set only stores the revised PRNU coefficients in the desired User Set.

These new features are found under the Flat Field tab and are only visible in Guru mode. Press "More >>" in CamExpert to display the full list of parameters. These features are similar to the SPR (Set PRNU Range) three letter command found in other Teledyne DALSA cameras (e.g. HS, Piranha3, and PC-30 cameras) that allow the user to set a range of PRNU values. The new feature is different in that it keeps the existing user PRNU calibration and simply scales a region up or down, thus preserving the flat field calibration.

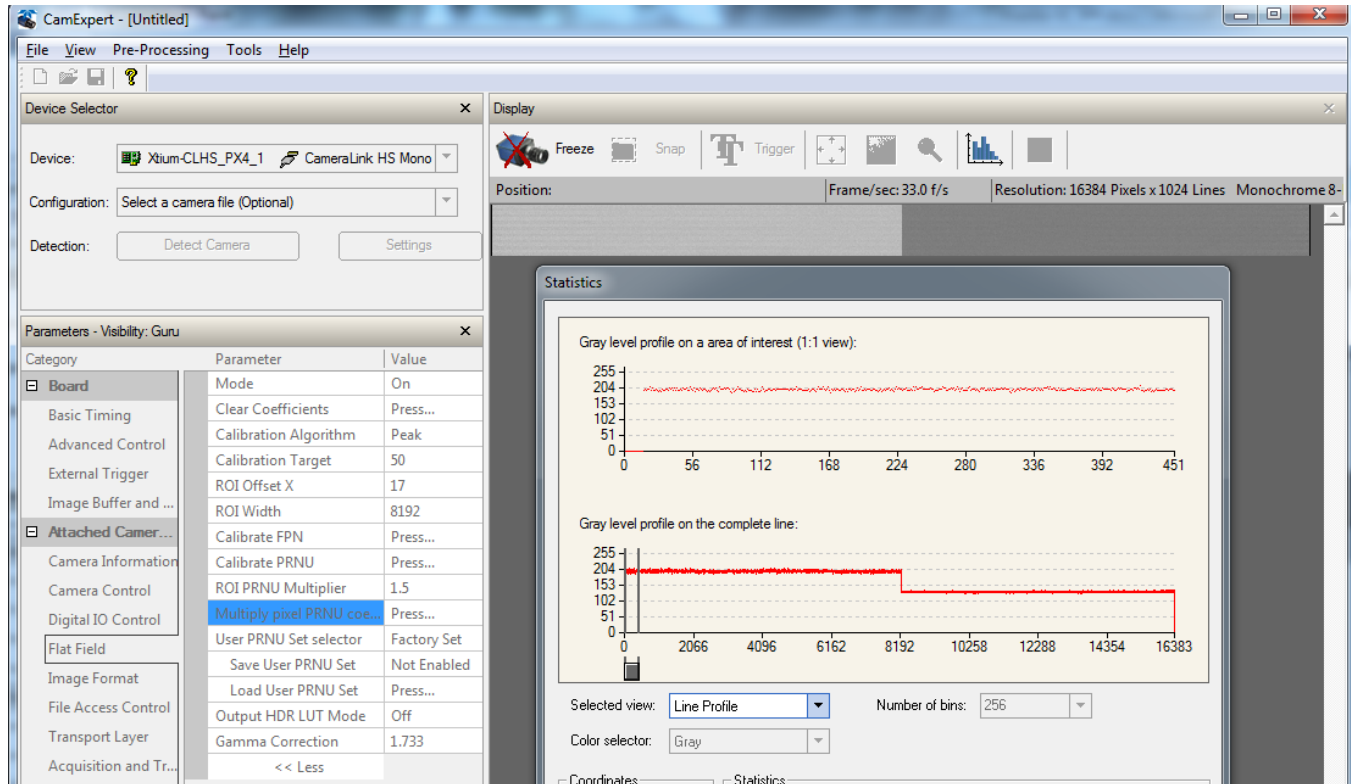

Note that as with setting a Flat Field Calibration target level below the peak level at low gains, setting a PRNU multiplier less than one at a low system gain may also produce a premature clipping of the output.

*This feature is only available in the PX-HM-16K06X and PX-HM-16K12X camera models.

Saving & Rapid Loading a PRNU Set Only

Loading a user set takes two seconds while loading only the user PRNU coefficients takes just 65 milliseconds.

Use the User PRNU Set Selector parameter to select the set you want to save or load. (There are nine sets available—eight user and one factory.) Note that the *Factory Set* is read-only and contains all ones. Loading the Factory Set is a good way to clear just the user PRNU.

Save the current user PRNU coefficients with the "Save User PRNU Set" parameter. Load the user PRNU coefficients from the set specified with "User PRNU Set Selector" and with the "Load User PRNU Set" command feature.

Setting Custom Flat Field Coefficients

There may also be circumstances when the user wants to upload their own Flat Field (PRNU) coefficients. Flat Field coefficients can be custom modified and uploaded to the camera. They can also be downloaded from the camera.

To download and upload PRNU coefficients, use *File Access Control Category > Upload / Download File > Settings* and select *Miscellaneous > Current PRNU* to download / upload a file. The file format is described in 03-084-20123 Piranha XL Binary File Format which can be obtained from Teledyne DALSA Technical Support. This document also includes Excel spread sheet examples.

Once the PRNU coefficients are uploaded, they are used immediately by the camera. To avoid loss at power up or changing row settings, they should be saved in one of the 8 available user sets.

Flat Field Calibration Filter

See the section Flat Field Category in Appendix A for GenICam features associated with this section and how to use them

Relevant Features: Calibration Algorithm

If a sheet of material is being used as a white target, it must be completely free of blemishes and texture. Any dirt or texture present will generate a variation in the image that will be incorporated into the calibration coefficients of the camera. Once the target is removed, or moved, vertical stripes will be present in the scanned image. Dirt or texture that has dark characteristics will appear as bright vertical lines. And dirt or texture that has bright characteristics will appear as dark vertical lines. One way to minimize this affect is for the white target to be moving during the calibration process. This has the effect of averaging out any dirt or texture present. If this is not possible, the camera has a feature where a flat field calibration filter can be enabled when generating the flat field correction coefficients which can minimize the effects of dirt. Note that this filter is only capable of compensating for small, occasional contaminants.

Flat Field Calibration Region of Interest

See the section Flat Field Category in Appendix A for GenICam features associated with this section and how to use them

Relevant Features: ROI Offset X, ROI Width

There are occasions when the camera's field of view includes areas that are beyond the material to be inspected. This may occur for cameras imaging off the edge of a panel or web. Another type of inspection system may be imaging multiple lanes of material. The edge of the material or between lanes may not be illuminated in the same way as the areas of inspection and, therefore, would cause problems with a flat field calibration. The camera can accommodate these "no inspection zones" by defining up to four Regions of Interest (ROI) where flat field calibration is performed. Image data outside the ROI is ignored by the flat field calibration algorithm. Each ROI is user selected with the pixel boundaries defined by the pixel start address and pixel width and then followed by initiating flat field calibration for that region. Once completed, the next ROI can be defined and flat field calibrated.

Selecting 16,352 or 16,384 Active Pixels of Image Data*

See the section Flat Field Category in Appendix A for GenICam features associated with this section and how to use them

Relevant Features: Image Magnification Mode

(Note: this feature is only available on the 06X and 12X models of camera.)

The camera has 16,352 active pixels. 16 pixels at each end are reserved for dynamically optimizing imaging data. When it is critical for an application to have 16,384 active pixels of image data, the Image Magnification feature can be used. When this feature is active, the 16,352 pixels are magnified by 1.002x (16384/16352). This results in the 16 black pixels at each end being replaced with image data, resulting in a 16,384 pixel wide image.

Note that the image magnification algorithm has a slight filtering effect that may reduce the contrast of very small features. However, it also has the effect of reducing noise.

When the camera powers up, it will default to the Image Magnification Mode Off, as this will be backwards compatible with the operation of earlier cameras.

*This feature is only available in the PX-HM-16K06X and PX-HM-16K12X camera models.

Achieving Faster Scan Speeds When Lower Image Resolution Is Acceptable (Binning)

See the section Image Format Control Category in Appendix A for GenICam features associated with this section and how to use them

Relevant Features: Horizontal Binning, Vertical Binning

In certain applications, lower image resolution may be acceptable if the desired defect detection can still be achieved. This accommodation can result in higher scan speeds, as the distance travelled per encoder pulse is increased due to the larger object pixel size. The Piranha XL camera has a binning feature that produces rapid adjustment to a lower object pixel resolution without having to change the optics, illumination intensity, or encoder pulse resolution.

Binning is a process whereby adjacent pixels are summed. The Piranha XL camera can support 1 x 2, 2 x 1, and 2 x 2 binning (vertical x horizontal). Vertical Binning is achieved by the camera ignoring every other encoder pulse. Horizontal binning is achieved by averaging adjacent pixels in the same line. Therefore, 2x binning results in the object pixel doubling in size vertically, horizontally, or in both axes, as selected by the Binning feature. When selecting binning, the current exposure time is retained so no change in light level is required. As every other encoder pulse is dropped with 2x vertical binning, scan speed can double without exceeding the maximum specified line rate, or the maximum line rate as dictated by the selected exposure time. Horizontal 2x binning will halve the amount of image data out of the camera. This can be used to save processing bandwidth in the host and storage space by creating smaller image file sizes.

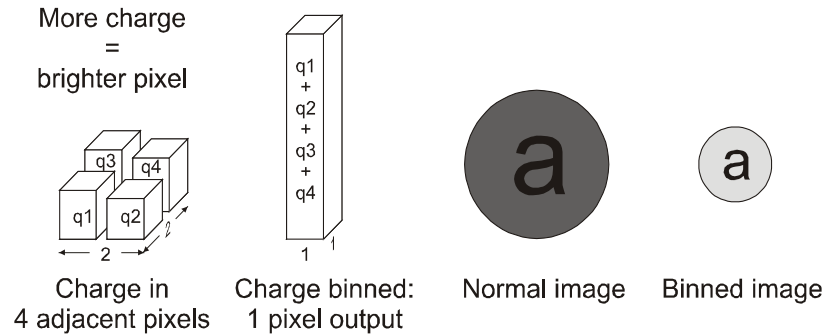

Figure 8: 2x2 Binning

For the Piranha XL camera, the default binning value is 1 x 1.

Note: The Binning parameters can only be changed when image transfer to the frame grabber is stopped. Refer to the "Acquisition and Transfer Control" category in the appendix for details on stopping and starting the acquisition.

Using Area of Interest to Reduce Image Data & Enhance Performance

See the section *Image Format Control Category in Appendix A for GenICam features associated with this section and how to use them*

Relevant Features: AOI Port Selector, AOI Count, AOI Selector, AOI Offset, AOI Width

If the camera's field of view includes areas that are not needed for inspection (also refer to the description in the 0 Flat Field Calibration Region of Interest), then the user may want to ignore this superfluous image data. Eliminating unwanted image data that is present in the camera's field of view reduces the amount of information the host computer needs to process. It may also result in an increase to the maximum allowable line rate when using 12 bit output data.

Different Areas of Interest can also be selected to be output on the Master and Slave ports. This would allow the camera to be connected to a dual port frame grabber or two frame grabbers, possibly in two PC's. Using this configuration may eliminate frame grabber and/or PC bandwidth issues allowing the camera to achieve its maximum line rate.

The Piranha XL camera can accommodate up to four Areas of Interest (AOI) for each of the Master & Slave ports. Image data outside the AOI are discarded. Each AOI is user selected and its pixel boundaries defined. The camera will assemble all individual AOI into one contiguous image line with a width equal to the sum of the individual AOI('s). The frame grabber will need to be adjusted to accommodate the smaller overall image width. As the host computer defined the size of each individual AOI, it will be able to extract and process each individual AOI from the one larger image.

Steps to Setup Area of Interest

1. Plan your AOI's
2. Stop acquisition
3. Select the Master or Slave port
4. Set the number of AOI's
5. Select the first AOI and set the offset and width
6. If the other AOI's are large you may need to select them first and reduce their width's
7. Repeat for each AOI in turn

8. Start acquisition

The Rules for Setting Areas of Interest

Notes:

- The rules are dictated by how image data is organized for transmission over the available CLHS data lanes.
 - The camera/XML will enforce these rules truncating entered values where necessary.
1. Acquisition must be stopped to change the AOI configuration
 2. 1-4 AOI's can be selected
 3. Minimum width is 96 pixels per AOI
 - a. Minimum total of all AOI widths summed together must be at least = Number of CLHS lanes x 96 pixels
 - i. 7 lanes: 672 pixels (Normal Use)
 - ii. 4 lanes: 384 pixels (When using CX4 fiber cable modules)
 4. Maximum width of all AOI widths summed together must be no more than = $16,384 + (3 \times 96) = 16,672$
 - a. There can be maximum 8k bytes per CLHS lane when using only 4 lanes, such as with a CX4 fiber module. i.e.
 - i. 8192 pixels per lane can be supported when using 8 bit pixels
 - ii. 5,461 pixels per lane can be supported when using 12 bit pixels
 5. AOI width step size is 32 pixels
 6. The offset of each AOI may be 0 to $(16,384 - 96 = 16,288)$
 - a. Therefore overlapping AOI's are allowed
 7. Offset and width for individual AOI's will "push" one another
 - a. e.g. if AOI has offset 0, width 16,384, and the offset is changed to 4096, then the width will be "pushed" to 12,288.
 - b. AOI's only effect one another by limiting the maximum width
 8. AOI's are concatenated together in numerical order and sent to the frame grabber starting at column zero
 9. "Extreme" differences in AOI width's will reduce the maximum line rate
 - a. e.g. If AOI #1 is 16,384 x 12 bit pixels and the other three AOI's are just 96 pixels then with a seven lane CLHS cable the maximum line rate will be ~50.8 kHz
 10. If the AOI count is reduced to less than the current AOI count, the AOI selector will be changed to the largest of the new AOI count available

Increasing Dynamic Range (LUT)

See the section *Camera Control Category in Appendix A for GenICam features associated with this section and how to use them*

Relevant Features: Output LUT Mode, HDR Gamma Correction

To enhance the camera's ability to detect defects from the dark and bright areas of an image, a high dynamic range look-up table (HDR LUT) is available.

When the LUT is enabled, 12 bit image data within the camera is compressed into an 8 bit output from the camera using a conversion table that can be internally generated using a 'gamma' type algorithm or a conversion table that is downloaded by the user. The gamma correction value can be adjusted by the user at any time.

The algorithm used by the camera to convert 12bit linear data to 8bit 'gamma type' encoded data is as follows:

$8\text{bit_gamma} = 255.0 * ((\text{RGB_12bit_linear}/4095.0) ^ (1.0/\text{gamma}))$, where gamma = 1.0 to 3.0

When the LUT is enabled, there is no change in maximum line rate or amount of data output from the camera. The LUT can be used with any mode of the camera.

Further, when the LUT is enabled, it is recommended that the fixed Offset available in the Camera Control category be set to zero.

To upload a LUT, use *File Access Control Category > Upload / Download File > Settings* and select *Look Up Table* to upload a file. The file format is described in 03-084-20123 Piranha XL Binary File Format which can be obtained from Teledyne DALSA Technical Support. This document also includes Excel spread sheet examples.

Contrast Enhancement

See the section *Camera Control Category in Appendix A for GenICam features associated with this section and how to use them*

Relevant Features: Offset, Gain

When the image does not contain useful dark image data below a particular threshold, it may be beneficial to increase the contrast of the image. The Piranha XL camera has an offset feature that allows a selectable level to be subtracted from the image data. The gain feature can then be used to return the peak image data to near output saturation with the result being increased image contrast.

First, determine the offset value you need to subtract from the image with the current gain setting you are using. Then set this negative offset value and apply additional gain to achieve the desired peak image data values.

Note: A positive offset value is not useful for contrast enhancement. However, it can be used while measuring the dark noise level of the camera to ensure zero clipping is not present.

Help with Lens Focusing & Camera Alignment

See the section *Camera Control Category in Appendix A for GenICam features associated with this section and how to use them*

Before evaluating the cameras imaging performance, it is important to ensure that the image is properly focused and that the camera's 16k pixel axis is perpendicular to the motion of the object.

Establish Optimum focus

The target being used for focus adjustment should have sharp black-to-white transitions and as much fine detail as possible. Ideally, black and white features of approximately 10 pixels or less wide will be in the image. A back illuminated USAF 1951 target may be suitable.

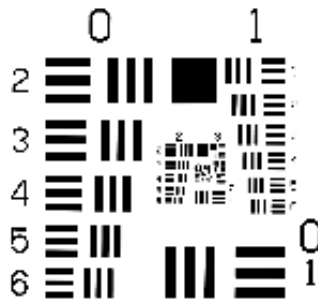

Figure 9 USAF 1951 'Positive'

- Ensure that the lens aperture is fully open.
- Select the cameras 12 row mode.
- Select the low gain range and 1x gain.
- Select a slow internal line rate of 5 kHz.
- Set exposure time to 100 μ sec.
- Use the factory calibration settings.
- Adjust the target so that the fine details appear in the camera's field of view. Adjust the camera's gain so that the white parts of the image are at high values, but not saturated. If the response is too high at 1x gain, then reduce the exposure time to 25 μ sec or lower. Use CamExpert to capture, display, and analyze the image. If insufficient response is achieved at high gain, use the next highest gain range
- Select the CamExpert histogram analysis tool.
- Using the mouse, drag a box over the image area with lots of fine detail you want to use for focusing. The target should be stationary.
- Adjust the lens' focus helical or the camera's working distance to the object until the histogram shows a maximum of dark and light peaks with the largest separation and the lowest level of grey peaks.
- Optimum focus should now be achieved.

Ensuring Rows are Aligned to the Object Motion

To achieve the best image quality, it is important that the object motion tracks across the CMOS TDI rows without any up or down movement. One method of achieving this is to align the CMOS TDI rows to the object motion by using a stationary target located at the object plane, which has a

black-to-white single, sharp transition perpendicular to the direction of motion, and is in focus. The black to white transition should be located at the point where all the cameras are to be optically aligned.

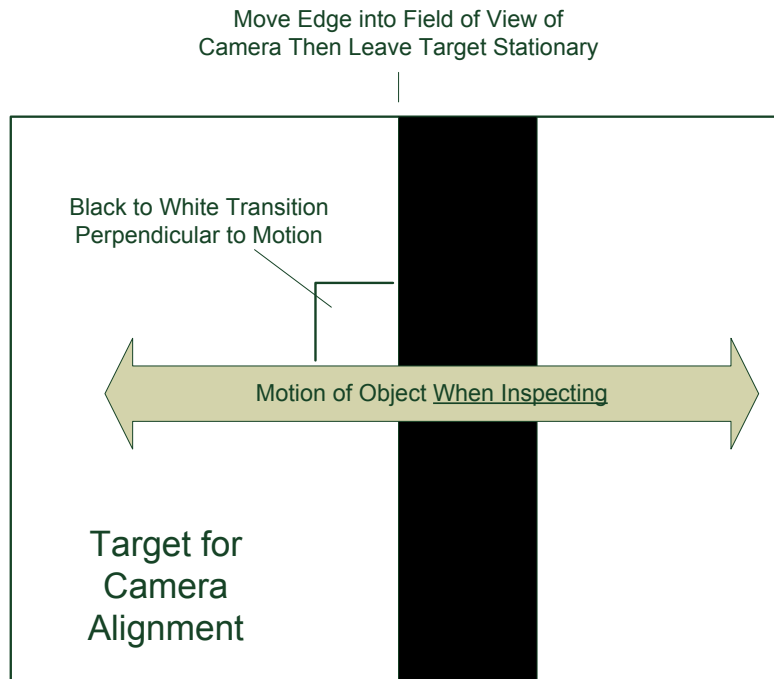

Note: It is assumed that the camera mounting system has the ability to rotationally adjust the camera about its central axis and in the scan direction to perform the desired alignment.

- Select the CamExpert line profile analysis tool.
- Continue using the camera setup in 12 row mode and continuous imaging.
- Align the camera such that only the white, fully illuminated portion is being imaged. This can be determined when rotational and scan direction adjustments of the camera do not result in changes in the image line profile.
- Adjust the illumination, exposure time and/or gain to achieve a peak value of approximately 200 DN.
- Perform a Flat Field calibration with a target of 200 DN.
- Adjust the camera in the scan direction such that the center of the image is 100 DN. This will align the black-to-white transition at the center of the FOV to the center rows of the camera.
- While watching the line profile, rotate the camera and make both ends of the sensor equal to the center value. The line transition at the center of the image should not move. If it does, it means that the camera is not being rotated around its center axis. Adjust the camera in the scan direction until the center value again reaches 100 DN.
- When both end of the line profile are equal to the center, then the camera will be aligned both in the scan direction and rotationally with the black-to-white transition.
- The accuracy of the adjustment can be increased by using 8 rows. However, this will be associated with an increase in sensitivity to camera adjustments. Start with 12 rows to get

close and then move to 8 rows. Ensure that the 8 rows is also Flat Fielded to the same target as 12 rows.

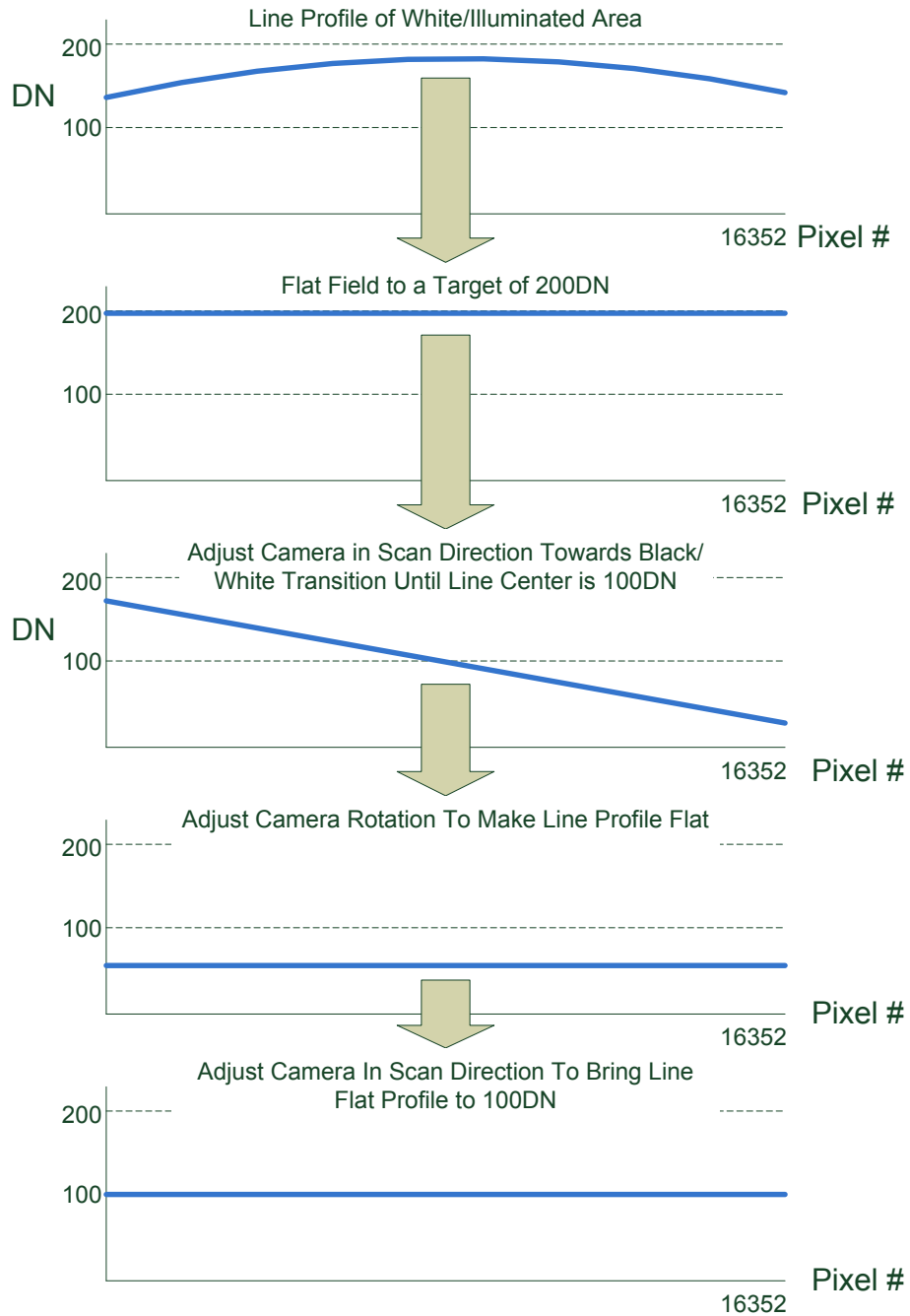

Figure 10 Alignment Method

This method is not effective for CCD TDI cameras with many stages as there is insufficient sensitivity. Area mode imaging is required. Single line cameras would be too sensitive. However, the Piranha XL camera has the right number of rows to make this simple alignment method practical.

Changing Output Configuration

Bit Resolution

See the section *Image Format Control Category in Appendix A for GenICam features associated with this section and how to use them*

Relevant Features: Pixel Format

The camera can output video data as 8-bit or 12-bit format. 8-bit output allows for the maximum specified line rate to be achieved. 12-bit data limits the maximum line rate to approximately 2/3rd of the maximum specified line rate, when using a single Camera Link HS cable. The maximum line rate can be restored if the image data is split equally across two Camera Link HS cables.

Note: the Bit resolution parameter can only be changed when image transfer to the frame grabber is stopped. Refer to the "Acquisition and Transfer Control" category in the appendix for details on stopping and starting acquisitions.

Camera Link HS Lane Selection

See the section *Image Format Control Category in Appendix A for GenICam features associated with this section and how to use them*

Relevant Features: Next CLHS Devise Configuration

Each Camera Link HS cable includes 8 lanes. One lane is used to send command data from the frame grabber to the camera. Seven lanes are use to send camera data to the frame grabber, one of which carries both image and command response data. The camera can also support the use of only 4 lanes, which allows standard fiber modules to be plugged into the camera, or 1 lane which may be useful for diagnostic purposes.

Use the 'Next CLHS Devise Configuration' to select the desired lane configuration. Ensure that the acquisition is stopped when performing lane configuration selection. The frame grabber must also have the same lane selection.

Note that this feature also controls the cable selection.

Using Two CLHS Cables

See the section *Image Format Control Category in Appendix A for GenICam features associated with this section and how to use them*

Relevant Features: Next CLHS Devise Configuration

The camera has two CLHS compliant connectors. Control / Data1 is assigned as the master with Data 2 connector as the slave. Use the 'Next CLHS Devise Configuration' to select the desired number of cables. This feature also controls lane selection.

Note that when using two cables with two frame grabbers both frame grabbers must be operational *before* the camera is powered ON. This ensures that the frame grabber master and slave designations are correctly assigned by the camera. If both frame grabbers are configured for master, then the frame grabber connected to the CONTROL / DATA 1 port will be assigned as the master by the camera.

Using Fiber Modules

The Piranha XL camera is capable of supporting one or two “CX4 Active Optical” fiber modules, which can have cable lengths up to 300 meters. The fiber module plugs directly into the camera connectors, which provide both communication and power to the module. CX4 fiber modules support four receiver lines, which results in only four image data lanes with one also carrying command response data and being available from the camera to the frame grabber. CX4 also has four transmit lines. One of which is used for the command channel from the frame grabber to the camera. This results in reduced image data bandwidth when using fiber modules. See section Camera Link HS for line rate performance with and without fiber modules.

Note that CX4 fiber modules must have jack screws to secure the module to the camera.

Saving & Restoring Camera Setup Configurations

See the section Camera Information Category in Appendix A for GenICam features associated with this section and how to use them

Relevant Features: Power-up Configuration Selector, UserSet1 thru UserSet8, User Set Selector, Power-on User Set, Current User Set

An inspection system may require several different illumination, resolution, and responsivity configurations in order to cover the different types of inspection it is expected to perform. The Piranha XL camera includes 8 user sets where camera setup information can be saved to and restored from—either at power up, or dynamically during inspection. The camera’s active settings can be derived from one of four settings:

1. Set by GenICam command from host.
2. User setting.
3. Factory setting (read-only).
4. Default setting.

The settings active during the current operation can be saved (and thereby become the user setting) using the user set save parameter.

A previously saved user setting (User Set 1 to 8) or the factory settings can be restored using the user set selector and user set load parameters.

Either the factory setting or one of the user settings can be saved as the default setting, by selecting the set in the user set default selector. The set selected automatically saves as the default setting and is the set that is loaded and that becomes active when the camera is reset or powered up.

The relationship between these four settings is illustrated in Figure 11. Relationship between the Camera Settings:

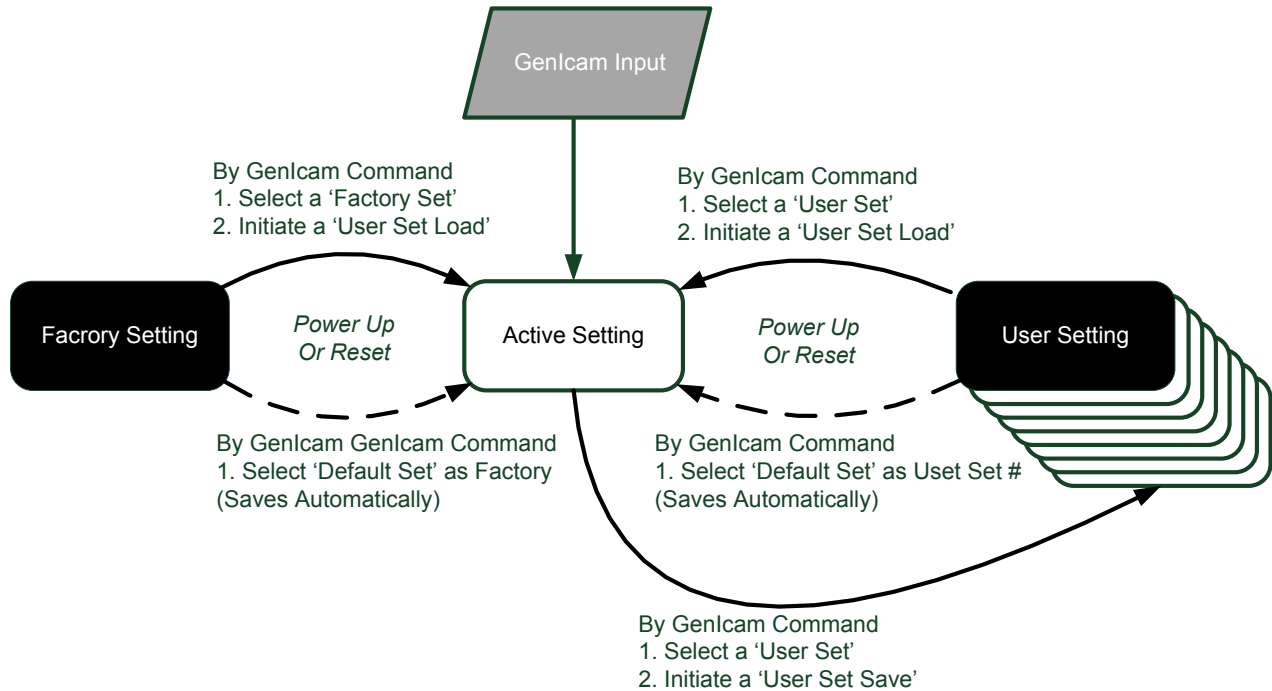

Figure 11. Relationship between the Camera Settings

Active Settings for Current Operation

Active settings are those settings used while the camera is running. And include all unsaved changes made by GenICam input to the settings.

These active settings are stored in the camera's *volatile* memory and will be lost and cannot be restored if the camera resets, is powered down, or loses power during operation.

To save these settings so that they can be restored next time you power up the camera, or to protect against losing them in the case of power loss, you must save the current settings using the user set save parameter. Once saved, the current settings become the selected user set.

User Setting

The user setting is the saved set of camera configurations that you can customize, resave, and restore. By default, the user settings are shipped with the same settings as the factory set.

The command user set save saves the current settings to non-volatile memory as a user set. The camera automatically restores the last saved user settings when it powers up.

To restore the last saved user settings, select the user set parameter you want to restore and then select the user set load parameter.

Factory Settings

The factory setting is the camera settings that were shipped with the camera and which loaded during the camera's first power-up. To load or restore the original factory settings, at any time, select the factory setting parameter and then select the user set load parameter.

Note: By default, the user settings are set to the factory settings.

Default Setting

Either the factory or one of the user settings can be used as the default setting, by selecting the set to use in the user set default selector. The chosen set automatically becomes the default setting and is the set loaded when the camera is reset or powered up.

Appendix A: GenICam Commands

This appendix lists the available GenICam camera features. The user accesses these features using the CamExpert interface.

Features listed in the description table but tagged as *Invisible* are typically reserved for Teledyne DALSA Support or third party software usage, and not typically required by end user applications.

The following feature tables describe these parameters along with their view attributes and in which version of the device the feature was introduced. Additionally the Device Version column will indicate which parameter is a member of the DALSA Features Naming Convention (using the tag **DFNC**), versus the GenICam Standard Features Naming Convention (SFNC tag not shown).

In the CamExpert Panes, parameters in gray are read only, either always or due to another parameter being disabled. Parameters in black are user set in CamExpert or programmable via an imaging application

The Device Version number represents the camera software functional group, not a firmware revision number.

A note on the CamExpert examples shown here: The examples shown for illustrative purposes and may not entirely reflect the features and parameters available from the camera model used in your application.

Camera Information Category

Camera information can be retrieved via a controlling application. Parameters such as camera model, firmware version, etc. are read to uniquely identify the connected Piranha XL camera. These features are typically read-only.

The Camera Information Category groups information specific to the individual camera. In this category the number of features shown is identical whether the view is Beginner, Expert, or Guru.

Parameters - Visibility: Guru		
Category	Parameter	Value
Camera Information	Model	PX-HM-16K12B-00-R
Camera Control	Vendor	Teledyne_DALSA
Digital IO Control	Serial Number	CAM_29
Flat Field	Microcode Version	03-081-20341-01
Image Format	XML Version	03-119-20047-02
File Access Control	FPGA Version	03-056-20464-02
Transport Layer	Script Version	03-110-20344-01
Acquisition and Transfer Cont...	Power-on Status	Good
	Refresh BIST	Press...
	LED Color	Green
	Temperature	43.5
	Refresh Temperature	Press...
	Input Voltage	19.5 <input type="text"/>
	Refresh Voltage	Press...
	Power-up Configuration	Setting...
	<< Less	

Figure 12 CamExpert Camera Information Panel

Camera Information Feature Descriptions

Display Name	Feature	Description	Device Version & View
Model Name	DeviceModelName	Displays the device model name. (RO)	1.00 Beginner
Vendor Name	DeviceVendorName	Displays the device vendor name. (RO)	1.00 Beginner
Device Version	DeviceVersion	Displays the device version. This tag will also highlight if the firmware is a beta or custom design. (RO)	1.00 Beginner
Manufacturer Info	DeviceManufacturerInfo	This feature provides extended manufacturer information about the device. (RO)	1.00 Beginner

Display Name	Feature	Description	Device Version & View
Firmware Version	DeviceFirmwareVersion	Displays the currently loaded firmware version number. Firmware files have a unique number and have the .cbf file extension. (RO)	1.00 Beginner
Serial Number	DeviceID	Displays the device's factory set camera serial number. (RO)	1.00 Beginner
Device User ID	DeviceUserID	Feature to store user-programmable identifier of up to 15 characters. The default factory setting is the camera serial number. (RW)	1.00 Beginner
Restart Camera	DeviceReset	Used to restart the camera (Warm restart) Note: The CamExpert GUI suppresses this feature for CLHS cameras	1.00 Beginner
Power-up Configuration Selector	UserSetDefaultSelector	Selects the camera configuration set to load and make active on camera power-up or reset. The camera configuration sets are stored in camera non-volatile memory. (RW)	1.00 Beginner
Factory Setting	Default	Load factory default feature settings	
UserSet1	UserSet1	Select the user defined configuration UserSet 1 as the Power-up Configuration.	
UserSet2	UserSet2	Select the user defined configuration UserSet 2 as the Power-up Configuration	
UserSet3	UserSet3	Select the user defined configuration UserSet 3 as the Power-up Configuration	
UserSet4	UserSet4	Select the user defined configuration UserSet 4 as the Power-up Configuration.	
UserSet5	UserSet5	Select the user defined configuration UserSet 5 as the Power-up Configuration.	
UserSet6	UserSet6	Select the user defined configuration UserSet 6 as the Power-up Configuration.	
UserSet7	UserSet7	Select the user defined configuration UserSet 7 as the Power-up Configuration.	
UserSet8	UserSet8	Select the user defined configuration UserSet 8 as the Power-up Configuration.	
Load & Save Configuration	UserSetSelector	Selects the camera configuration set to load feature settings from or save current feature settings to. The Factory set contains default camera feature settings. (RW)	1.00 Beginner
Factory Setting	Default	Select the default camera feature settings saved by the factory	
UserSet 1	UserSet1	Select the User-defined Configuration space UserSet1 to save to or load from features settings previously saved by the user.	
UserSet 2	UserSet2	Select the User-defined Configuration space UserSet2 to save to or load from features settings previously saved by the user.	
UserSet3	UserSet3	Select the User-defined Configuration space UserSet3 to save to or load from features settings previously saved by the user.	
UserSet4	UserSet4	Select the User-defined Configuration space UserSet4 to save to or load from features settings previously saved by the user.	

Display Name	Feature	Description	Device Version & View
UserSet5	UserSet5	Select the User-defined Configuration space UserSet5 to save to or load from features settings previously saved by the user.	
UserSet6	UserSet6	Select the User-defined Configuration space UserSet6 to save to or load from features settings previously saved by the user.	
UserSet7	UserSet7	Select the User-defined Configuration space UserSet7 to save to or load from features settings previously saved by the user.	
UserSet8	UserSet8	Select the User-defined Configuration space UserSet8 to save to or load from features settings previously saved by the user.	
Power-on User Set	UserSetDefaultSelector	Allows the user to select between the factory set and 1 to 8 user sets to be loaded at power up	1.00 Beginner
Current User Set	UserSetSelector	Points to which user set (1-8) or factory set that is loaded or saved when the UserSetLoad or UserSetSave command is used	1.00 Beginner
Load Configuration	UserSetLoad	Loads the camera configuration set specified by the User Set Selector feature, to the camera and makes it active. (W)	1.00 Beginner
Save Configuration	UserSetSave	Saves the current camera configuration to the user set specified by the User Set Selector feature. The user sets are located on the camera in non-volatile memory. (W)	1.00 Beginner
Device Built-In Self Test Status	deviceBISTStatus	Determine the status of the device using the 'Built-In Self Test' (BIST). Possible return values are device-specific. (RO) See Built-In Self-Test Codes for status code details	1.00 DFNC Beginner
LED Color	deviceLEDCColorControl	Displays the status of the LED on the back of the camera. (RO)	1.00 DFNC Beginner
Temperature	deviceTemperature	Displays the internal operating temperature of the camera. (RO)	1.00 DFNC Beginner
Refresh Temperature	refreshTemperature	Press to display the current internal operating temperature of the camera.	1.00 DFNC Beginner
Input Voltage	deviceInputVoltage	Displays the input voltage to the camera at the power connector (RO)	1.00 DFNC Beginner
Refresh Voltage	refreshVoltage	Press to display the current input voltage of the camera at the power connector	1.00 DFNC Beginner
License Key	securityUpgrade	TBD	1.00 DFNC Guru

Built-In Self-Test Codes (BIST)

In the Camera Information screen shot example above, the Power-On Status is showing the 23 status flags where '1' is signaling an issue. When there are no issues, the Power-On status will indicated "Good".

Details of the BIST codes can be found in the Trouble Shooting Guide in Appendix B.

Camera Power-Up Configuration Selection Dialog

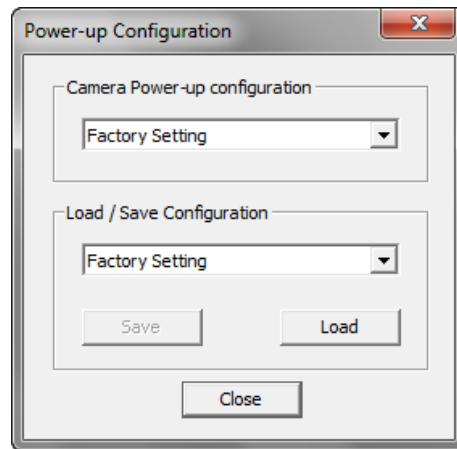

CamExpert provides a dialog box which combines the menu option used to select the camera's power-up state and the options for the user to save or load a camera state as a specific user set that is retained in the camera's non-volatile memory.

Camera Power-up Configuration

The first drop list selects the camera configuration state to load on power-up (see feature *UserSetDefaultSelector*). The user chooses from one factory data set or from one of eight available user-saved states.

User Set Configuration Management

The second drop list allows the user to change the camera configuration anytime after a power-up (see feature *UserSetSelector*). To reset the camera to the factory configuration, select *Factory Setting* and click Load. To save a current camera configuration, select User Set 1 to 8 and click Save. Select a saved user set and click Load to restore a saved configuration.

Camera Control Category

The Piranha XL camera control category, as shown by CamExpert, groups control parameters such as line rate, exposure time, scan direction, and gain.

Parameters - Visibility: Guru		
Category	Parameter	Value
Camera Information	Device Scan Type	TDI Scan
Camera Control	Sensor ColorType	Monochrome
Digital IO Control	Acquisition Line Rate	40000
Flat Field	Measured Line Rate	39989
Image Format	Refresh Measured Line Rate	Press...
File Access Control	Row Selector	12 Rows
Transport Layer	Exposure Mode	Timed
Acquisition and Transfer Control	Exposure Time	12
	Direction Source	Internal
	Internal Scan Direction	Forward
	Current Direction	Forward
	Refresh Current Direction	Press...
	Offset	5
	Extended Gain Range	Disable
	Gain	1
	<< Less	

Figure 13: Camera Control Panel

Camera Control Feature Descriptions

Display Name	Feature	Description	Device Version & View
Device Scan Type	DeviceScanType	Used to set the camera scanning mode. Only standard TDI mode is available.	1.00 Beginner SNFC
Standard			
Internal Line Rate	AcquisitionLineRate	Specifies the camera internal line rate, in Hz when Trigger mode set to internal. Note that any user entered value is automatically adjusted to a valid camera value.	1.00 Beginner
Measured Line Rate	measureLineRate	Specifies the line rate provided to the camera by either internal or external source (RO)	1.00 Beginner
Refresh Measured Line Rate	refreshMeasureLineRate	Press to show the current line rate provided to the camera by either internal or external sources	1.00 Beginner
Exposure Time Source	ExposureMode	Sets the operation mode for the camera's exposure (or shutter). (RO)	1.00 Beginner
Timed	Timed	The exposure duration time is set using the Exposure Time feature and the exposure starts with a LineStart event.	
Exposure Time	ExposureTime	Sets the exposure time (in microseconds) when the Exposure Mode feature is set to Timed.	1.00 Beginner

Display Name	Feature	Description	Device Version & View
Measured Exposure Time	measureExposureTime	Specifies the exposure time provided to the camera by either internal or external source (RO)	1.00 Beginner
Refreshed measured exposure time	refreshMeasureExposureTime	Press to display the current exposure time provided to the camera.	1.00 Beginner
Direction Source	sensorScanDirectionSource		1.00 Beginner
	Internal	Direction determined by value of SensorScanDirection	
	External	Direction control determined by value on CLHS GPIO bit 2, Frame grabber register #80524	
Internal Direction	sensorScanDirection	When ScanDirectionSource set to Internal, determines the direction of the scan	1.00 Beginner
	Forward		
	Reverse		
Row Selector	TDIStagesSelector	Selects the number of rows that will be used	1.00 Beginner
8 Rows		Adjusts the sensor characteristics to optimize for noise performance where the 4 rows would be selected first with the maximum available light. If there is insufficient response, add more rows.	
12 Rows			
Extended Gain Range	gainExtended	Increase the maximum allowable gain.	1.00 Guru
Gain	Gain	Sets the gain as per the gain selector setting	1.00 Beginner
Offset	BlackLevel	Controls the black level as an absolute physical value. This represents a DC offset applied to the video signal, in DN (digital number) units.	1.00 Beginner

Digital I / O Control Feature Descriptions

The camera's Digital I / O Control category is used to determine the source of the line sync generator. The line synchronization can be internally generated by the camera or from the frame grabber over the CLHS cable. CamExpert for the frame grabber can be used to then determine the line sync source such as from the shaft encoder input.

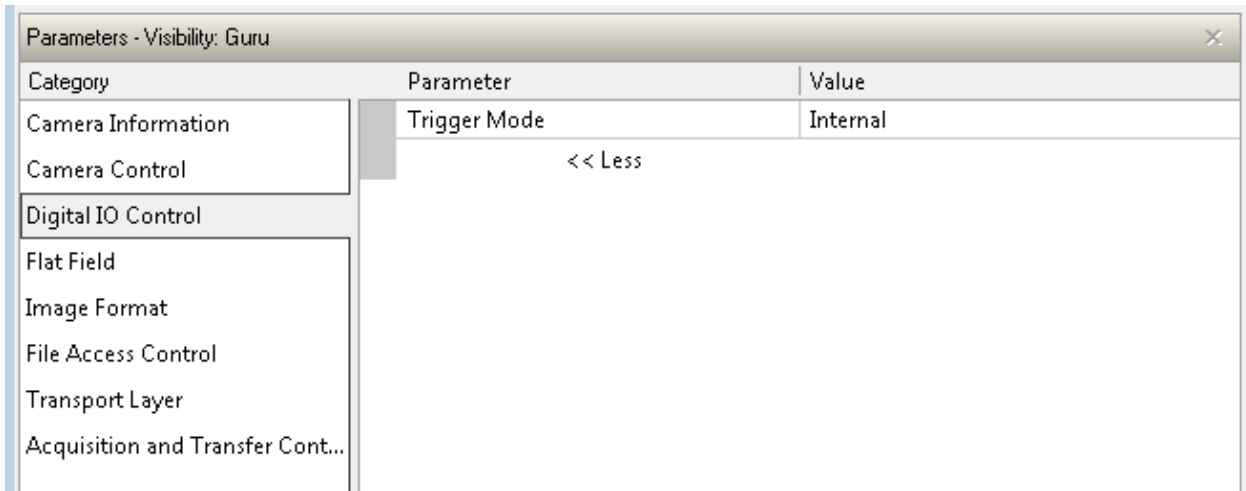

Figure 14 Digital I/O Control Panel

Display Name	Feature	Description	Device Version & View
Trigger Mode	Trigger Mode	Determines the source of trigger to the camera, internal or external	1.00 DFNC Beginner

Flat Field Category

The Piranha XL Flat Field controls, as shown by CamExpert, group parameters used to control the FPN and PRNU calibration process.

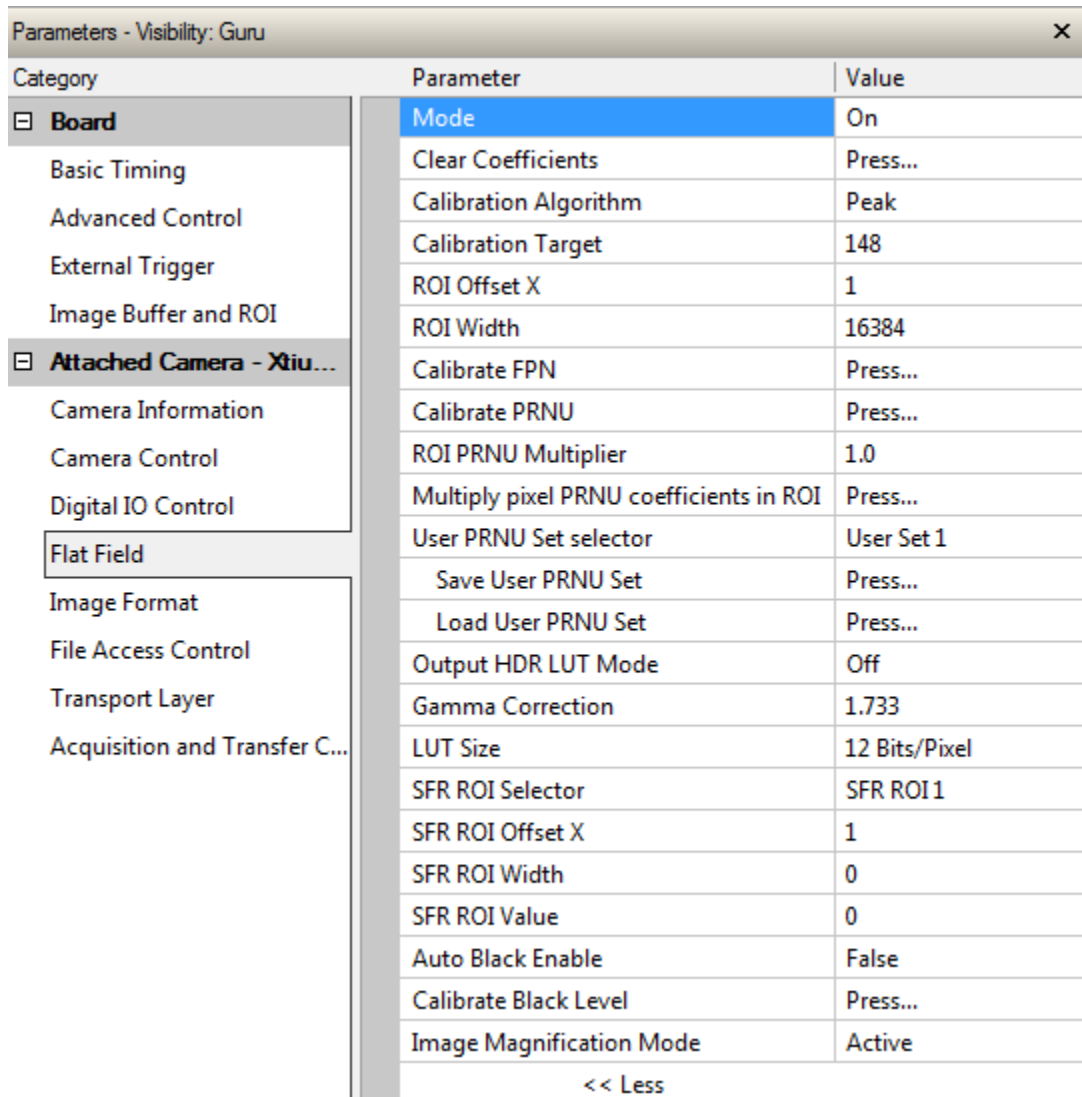

Figure 15: Flat Field Panel

Flat Field Control Feature Description

Display Name	Feature	Description	Device Version & View
Mode	flatfieldCorrectionMode		1.00
Off	Off	FPN and flat field coefficients disabled.	Beginner
On	On	FPN and flat field coefficients enabled.	DFNC
Clear Coefficients	Initialize	Reset all FPN to 0 and all flat field coefficients to 1.	
Calibration Algorithm	flatfieldCorrectionAlgorithm	Selection between two different flat field algorithms.	1.00 Beginner

Display Name	Feature	Description	Device Version & View
Peak	Peak	Calculation of PRNU coefficients to bring all pixels to the peak.	DFNC
Peak, Image Filtered	Peak, Image Filtered	A low pass filter is applied to the average line values before calculating the coefficients. Use this algorithm if the calibration target is not uniformly white or if it is not possible to defocus the image. Because of the low pass filter, this algorithm is not able to correct pixel-to-pixel variations and so it is preferable to use the "Peak" algorithm.	
Set Target	Set Target	Calculation of PRNU coefficients to bring all pixels to the target value.	
Set Target, Image Filtered	Set Target, Image Filtered	A low pass filter is applied to the average line values before calculating the coefficients. Use this algorithm if the calibration target is not uniformly white or if it is not possible to defocus the image. Because of the low pass filter this algorithm is not able to correct pixel-to-pixel variations and so it is preferable to use the "Target" algorithm.	
Calibration Target	flatfieldCalibrationTarget	Sets the target value for the "Calibrate PRNU" feature.	
ROI Offset X	flatfieldCalibrationROIOffsetX	Set the starting point of a region of interest where a flat field calibration will be performed	1.00 Beginner DFNC
ROI Width	flatfieldCalibrationROIWidth	Sets the width of the region on interest where a flat field calibration will be performed	1.00 Beginner DFNC
Calibrate FPN	flatfieldCalibrationFPN	Initiates the FPN calibration process	1.00 Beginner DFNC
Calibrate PRNU	flatfieldCalibrationPRNU	Initiates the Flat Field (PRNU) process	1.00 Beginner DFNC
ROI PRNU Multiplier	flatfieldRoiPrnu	Multiply pixel PRNU coefficients in ROI by the value given.	1.00 Guru DFNC
Multiply pixel PRNU coefficients in ROI	flatfieldSetRoiPrnu	Initiate multiplying PRNU coefficients in ROI. (Press again to undo).	1.00 Guru DFNC

Display Name	Feature	Description	Device Version & View
User PRNU Set selector	flatfieldCorrectionCurrentActiveSet	Selects the User PRNU set to be saved or loaded.	1.00 Guru DFNC
Factory Set	Factory Set	Factory set can only be loaded.	
User set (1 thru 8)	User set (1 thru 8)	Only the PRNU values are saved or loaded which is much faster than saving or loading the full Factory or User set.	
Save User PRNU Set	flatfieldCalifrationSave	Saves the User PRNU set specified by flatfieldCorrectionCurrentActiveSet to the camera.	1.00 Guru DFNC
Load User PRNU Set	flatfieldCalifrationLoad	Loads the User PRNU set specified by flatfieldCorrectionCurrentActiveSet to the camera and makes it active.	1.00 Guru DFNC
Output HDR LUT Mode	lutMode	Allows the output LUT to be selected	1.00 Beginner DFNC
Off	Off	The output LUT is disabled and linear data is output	
Gamma Correction	Gamma Correction	Gamma correction table is used	
User Defined	User Defined	LUT download by the user is used.	
Gamma Correction	gammaCorrection	Sets the output LUT gamma correction factor	1.00 Beginner DFNC
SFR ROI Selector	flatfieldSfrRoiSelector	Select 1 of the 4 'Set FPN Regions of Interest' to be adjusted	1.00 Guru DFNC
SFR ROI Offset X	flatfieldSfrRoiOffsetX	Sets the pixel offset of the selected 'Set FPN Regions of Interest'	1.00 Guru DFNC
SFR ROI Width	flatfieldSfrRoiWidth	Sets the pixel width of the selected 'Set FPN Regions of Interest'	1.00 Guru DFNC
SFR ROI Value	flatfieldSfrRoiValue	Sets how many DN the black level is shifted below the FPN level as selected 'Set FPN Regions of Interest'	1.00 Guru DFNC
Auto Black Enable	blackLevelEnable	Enables automatic matching of the eight 2K pixel wide black level segments	1.00 Expert DFNC
False	False	Turns off automatic black level segment matching	
True	True	Turns on automatic black level segment matching	
Calibrate Black Level	calibrateBlackLevel	When Auto Black Enable is False, initiating this feature will perform a black level segment matching operation. This can be initiated when light is present.	1.00 Expert DFNC

Display Name	Feature	Description	Device Version & View
Image Magnification Mode	imageMagnificationMode	When active, the image is magnified by 1.002x allowing the 16 black pixels at each end to be replaced with image data resulting in a 16,384 pixel wide image.	1.00 Beginner DFNC
Off	Off	Turns Image Magnification off. There will be 16 black pixels at each end of the image and 16,352 active pixels	
Active	Active	Turns Image Magnification ON resulting in a active 16,384 pixel data	

Image Format Control Category

The Piranha XL Image Format controls, as shown by CamExpert, group parameters used to configure camera pixel format, image cropping, binning and test pattern generation features.

Category	Parameter	Value
Camera Information	Pixel Format	Mono8
Camera Control	Pixel Color Filter	None
Digital IO Control	Width Max	16384
Flat Field	Horizontal Offset	0
Image Format	Output Width	16384
File Access Control	Height	1
Transport Layer	Binning Horizontal	1
Acquisition and Transfer Cont...	Binning Vertical	1
	Test Pattern	Off
	AOI Port Selector	Master
	AOI Count	1
	AOI Selector	1
	AOI Offset	0
	AOI Width	16384

<< Less

Figure 16: Image Format Panel

Image Format Control Feature Description

Display Name	Feature	Description	Device Version & View
--------------	---------	-------------	-----------------------

Test Pattern	TestImageSelector	Selects the type of test image that is sent by the camera. Choices are either as defined by SNFC and/or as provided by the device manufacturer.	1.00 Beginner DFNC
Off	Off	Selects sensor video to be output from sensor	
Each Tap Fixed	Each Tap Fixed	Selects a grey scale for each tap of the sensor	1.00 Beginner DFNC
Grey Horizontal Ramp	Grey Horizontal Ramp	Select a grey scale ramp for each tap of the sensor	
Pixel Format	Pixel Format	Output image pixel coding format of the sensor. For Piranha XL, this currently is 8,12 for normal TDI operation and 16 bits for high dynamic range 'Fusion' mode	1.00 Invisible DFNC
Mono8 Mono12 Mono16			
Vertical Binning	BinningVertical	Number of vertically adjacent pixels to sum together. This increases the intensity of the pixels and reduces the vertical resolution of the image	1.00 Beginner SFNC
Horizontal Binning	BinningHorizontal	Number of horizontally adjacent pixels to sum together. This increases the intensity of the pixels and reduces the horizontal resolution of the image	1.00 Beginner SFNC
AOI Count	multipleROICount	Specified the number of AOI's in an acquired image	1.00 Beginner SFNC
AOI Selector	multipleROISelector	Select 1 of up to 4 AOI's when setting the AOI Offset & AOI Width	1.00 Beginner SFNC
AOI Offset	multipleROIOffsetX	Location of the start of a single Area of a Interest to be output on the cable specified by CLHS Port AOI Selector feature	1.00 Beginner
AOI Width	multipleROIWidth	Width of the start of a single Area of a Interest to be output on the cable specified by CLHS Port AOI Selector feature	1.00 Beginner
AOI Port Selector	PortRoiSelector	Used to select which cable the AOI values are applied.	1.00 Beginner
Master Slave	Master Slave	Selects Master (Control/Data1) data port Selects Slave (Data2) data port	
Max Width	WidthMax	The maximum image horizontal dimension of the image. (RO)	1.00 Beginner
Height	Height	Height of the Image provided by the device (in lines). (RO)	1.00 Beginner
Input Pixel Size	pixelSizeInput	Size of the image input pixels, in bits per pixel. (RO)	1.00 DFNC Invisible
10 Bits/Pixel 12 Bits/Pixel 16 Bits/Pixel	Bpp10 Bpp12 Bpp 16	Senor input data path is 8, 12 or 16 bits per pixel.	

Transport Layer Control Category

Note: All features shown in Guru visibility.

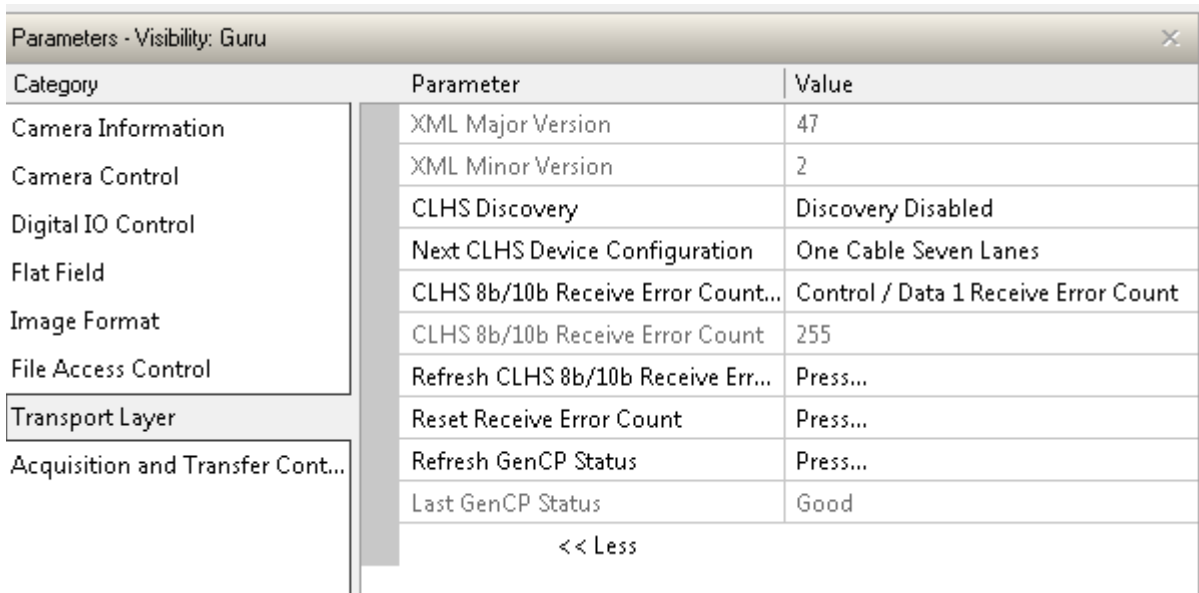

Figure 17: Transport Layer Panel

Transport Layer Feature Descriptions

Display Name	Feature	Description	Device Version & View
XML Major Version	DeviceManifestXMLMajorVersion	Together with DeviceManifestXMLMinorVersion specifies the GenICam™ feature description XML file version (RO)	1.00 Beginner DFNC
XML Minor Version	DeviceManifestXMLMinorVersion	Together with DeviceManifestXMLMajorVersion specifies the GenICam™ feature description XML file version (RO)	1.00 Beginner DFNC
Refresh GenCP Status	refreshGenCPStatus	Press to return the current status of the GenCP	1.00 Beginner
Last GenCP Status	genCPStatus	If a feature read or write fails then Spera only returns that it fails – read this feature to get the actual reason for the failure Returns the last error Reading this feature clears it	1.00 Beginner DFNC

CLHS Discovery	clhsDiscovery	Selects between CLHS discovery mode which automatically determines the configuration of the CLHS interface when enabled. When disabled, the frame grabber needs to have the configuration set by the user	1.00 Guru DFNC
Discovery Disabled		CLHS transmitters are enabled immediately on power up	
Discovery Enabled		CLHS transmitters enable after sending Acquisition start	
Next CLHS Device Configuration	clhsNext DeviceConfig	When the camera is next powered up, the specified CLHS lane configuration will be set for the camera.	1.00 Guru DFNC
One cable seven lanes			
One cable four lanes			
One cable one lanes			
Two cable seven lanes			
Two cable four lanes			
Two cable one lanes			
CLHS 8b/10b Receive Error Count selector	clhsErrorCountSelector	Selects the error count that the following three features apply to	1.00 Guru DFNC
Data 2 Receive Error Count			
Control/Data1 Receive Error Count			
CLHS 8b/10b Receive Error Count	clhsError Count	CLHS error count value for the selected data/control lanes (RO)	1.00 Guru DFNC
Refresh CLHS 8b/10b Receive Error Count	clhsError CountRefresh	When pressed, the error count is updated	1.00 Guru DFNC
Reset Receive Error Count	clhsErrorCountReset	When pressed, the error count is rest to zero	1.00 Guru DFNC

Acquisition and Transfer Control Category

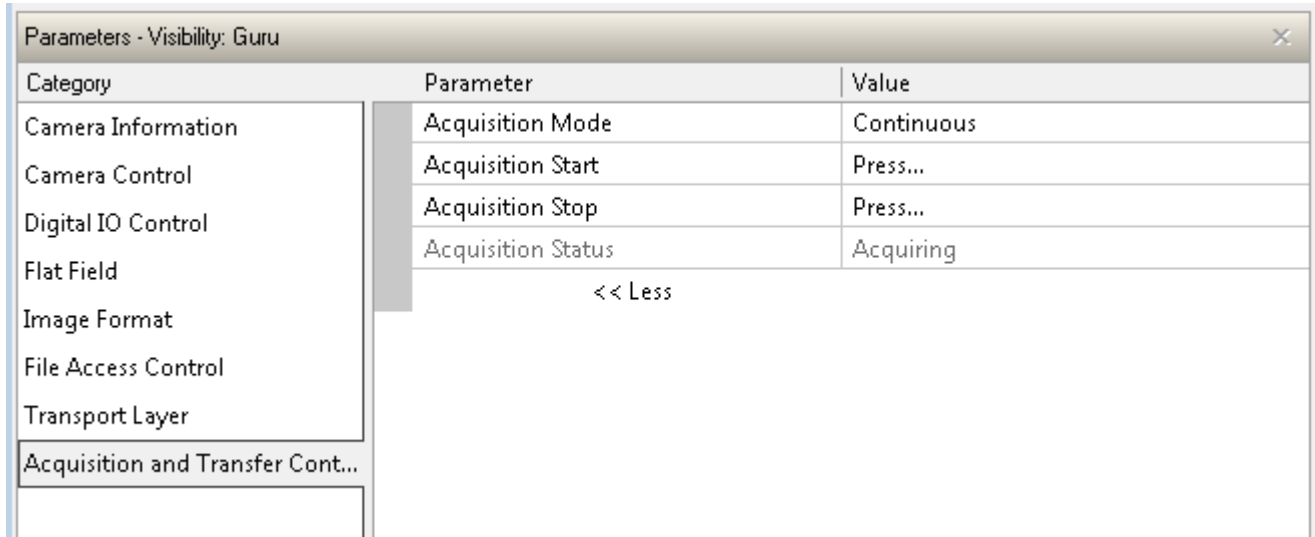

Figure 18: Acquisition & Transfer Control Panel

Acquisition and Transfer Control Feature Descriptions

Display Name	Feature	Description	Device Version & View
Acquisition Mode	AquisitionMode	The device acquisition mode defines the number of frames to capture during an acquisition and the way it stops Only continuous mode is currently available	1.00 Beginner DFNC
Continuous			
Acquisition Start	AquisitionStart	Starts the acquisition of image data. The number of frames captured is defined by the Acquisition Mode. (WO)	1.00 Beginner DFNC
Acquisition Stop	AquisitionStop	Stops the acquisition of image data at the end of the next frame(s) sequence (WO)	1.00 Beginner DFNC
Acquisition Status	AquisitionStatus	Indicates whether the camera has been commanded to stop or to send image data.	1.00 Beginner DFNC

File Access Control Category

The File Access control in CamExpert allows the user to quickly upload and download of various data files to the connected Piranha XL camera. The supported data files for the Piranha XL camera include firmware updates and Flat Field coefficients.

Note that the communication performance when reading and writing large files can be improved by stopping image acquisition during the transfer.

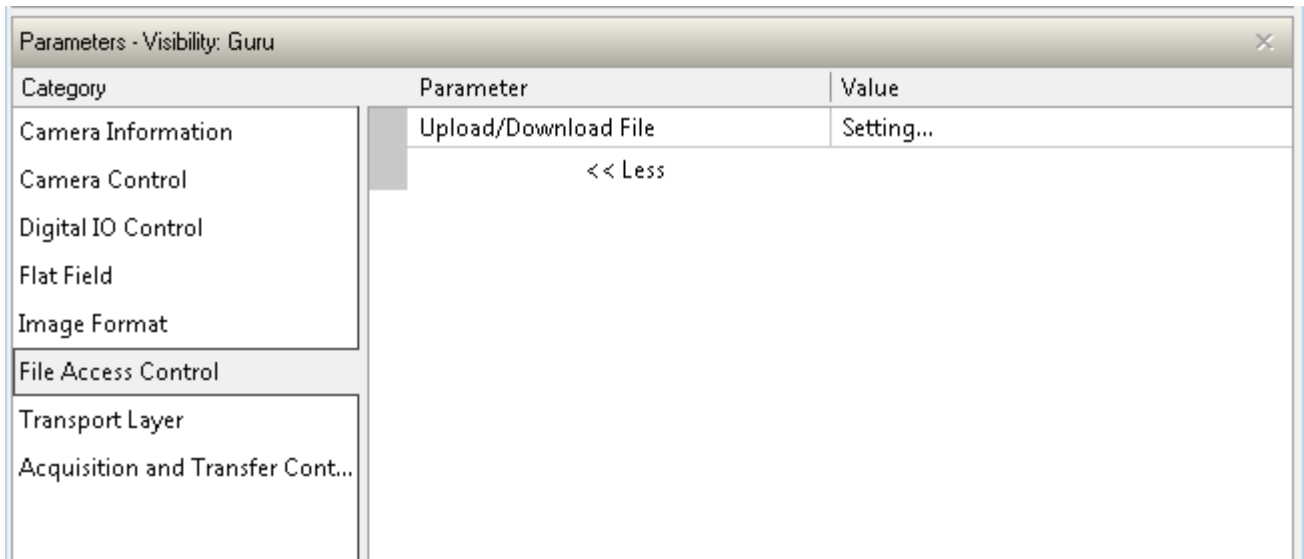

Figure 19: File Access Control Panel

File Access Control Feature Descriptions

Display Name	Feature	Description	View
File Selector	FileSelector	Selects the file to access. The file types which are accessible are device-dependent.	1.00 Beginner
All Firmware		Upload micro code, FPGA code & XML as a single file to the camera which will execute on the next camera reboot cycle.	DFNC
Microcode		Upload micro to the camera which will execute on the next camera reboot cycle.	
XML		Upload XML to the camera which will execute on the next camera reboot cycle	
User Set		Use UserSetSelector to specify which user set to access.	
User FlatField coefficients		Use UserSetSelector to specify which user flatfield to access.	
User FPN		Use UserSetSelector to specify which user FPN to access.	
CameraData		Download camera information and send for customer support.	
File Operation Selector	FileOperationSelector	Selects the target operation for the selected file in the device. This operation is executed when the File Operation Execute feature is called.	1.00 Guru
Open	Open	Select the Open operation - executed by FileOperationExecute.	
Close	Close	Select the Close operation - executed by FileOperationExecute.	
Read	Read	Select the Read operation - executed by FileOperationExecute.	
Write	Write	Select the Write operation - executed by FileOperationExecute.	
Delete	Delete	Select the Delete operation - executed by FileOperationExecute.	
File Operation Execute	FileOperationExecute	Executes the operation selected by File Operation Selector on the selected file.	1.00 Guru
File Open Mode	FileOpenMode	Selects the access mode used to open a file on the device.	1.00 Guru
Read	Read	Select READ only open mode	
Write	Write	Select WRITE only open mode	

Display Name	Feature	Description	View
File Access Buffer	FileAccessBuffer	Defines the intermediate access buffer that allows the exchange of data between the device file storage and the application.	1.00 Guru
File Access Offset	FileAccessOffset	Controls the mapping offset between the device file storage and the file access buffer.	1.00 Guru
File Access Length	FileAccessLength	Controls the mapping length between the device file storage and the file access buffer.	1.00 Guru
File Operation Status	FileOperationStatus	Displays the file operation execution status. (RO).	1.00 Guru
Success	Success	The last file operation has completed successfully.	
Failure	Failure	The last file operation has completed unsuccessfully for an unknown reason.	
File Unavailable	FileUnavailable	The last file operation has completed unsuccessfully because the file is currently unavailable.	
File Invalid	FileInvalid	The last file operation has completed unsuccessfully because the selected file is not present in this camera model.	
File Operation Result	FileOperationResult	Displays the file operation result. For Read or Write operations, the number of successfully read/written bytes is returned. (RO)	1.00 Guru
File Size	FileSize	Represents the size of the selected file in bytes.	1.00 Guru

File Access via the CamExpert Tool

1. Click on the “Setting...” button to show the file selection menu.

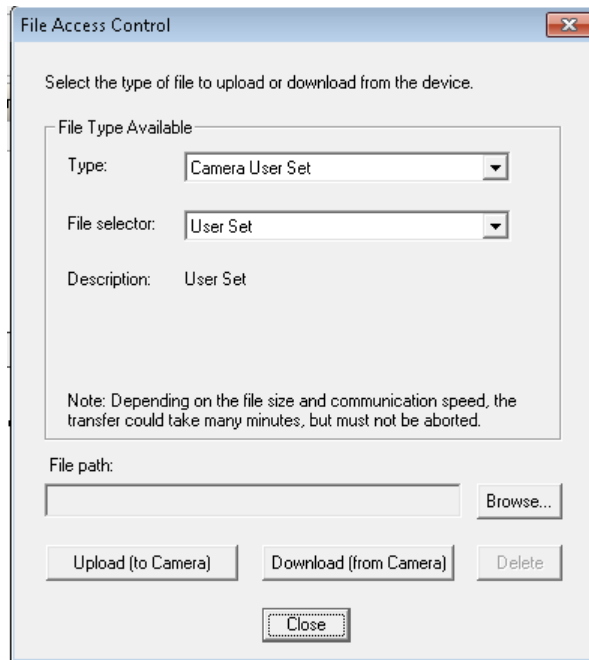

Figure 20: File Access Control Tool

2. From the Type drop menu, select the file type that will be uploaded to the camera.
3. From the File Selector drop menu, select the data to be uploaded.
4. Click the Browse button to open a typical Windows Explorer window.
5. Select the specific file from the system drive or from a network location.
6. Click the Upload button to execute the file transfer to the camera.
7. Note that firmware changes require that the camera be powered down and then back up. Additionally, CamExpert should be shut down and restarted following a reset.

Download a List of Camera Parameters

For diagnostic purposes you may want to download a list of all the parameters and values associated with the camera.

1. Go to File Access Control
2. Click on Settings
3. In the “Type” drop down box select “Miscellaneous.”
4. In the “File selector” drop down box select “CameraData.”
5. Hit “Download”
6. Save the text file and send the file to Teledyne DALSA customer support.

Appendix B: Trouble Shooting Guide

Diagnostic Tools

Camera Data File

The Camera Data file includes the operational configuration and status of the camera plus a record of recent commands sent to the camera along with status responses. This text file can be downloaded from the camera and forwarded to Teledyne DALSA Technical Customer support team to aid in diagnosis of any reported issues. See Saving & Restoring Camera Setup Configurations of the Piranha XL User Manual for details on downloading the Camera Data file.

Voltage & Temperature Measurement

The camera has the ability to measure the input supply voltage at the power connector and to measure the internal temperature. Both of these features can be accessed using the Camera CamExpertGUI > Camera Information tab. Press the associated refresh button to receive a real-time measurement.

Test Patterns – What can they indicate

The camera can generate fixed test patterns that may be used to determine the integrity of the CLHS communications beyond the Lock status. The test patterns give the user the ability to detect bit errors using an appropriate host application. This error detection would be difficult, if not impossible, using normal image data.

There are five test patterns that can be selected via the Cameras CamExpertGUI > Image Format tab. They have the following format when using 8-bit data.

- Each Tap Fixed
 - Starting at 08H increases in by 10H steps every 1K pixels ending in F8H except first and last 16 pixels are 01H
- Grey Horizontal Ramp
 - 64 horizontal ramps starting at 00H increases in by 01H every pixel ending in FFH except first and last 16 pixels are 01H
- Grey Vertical Ramp
- Grey Diagonal Ramp
- User Pattern
 - When selected, the camera will first output all pixels values to be half full scale. The user can then generate a custom test pattern by uploading PRNU coefficients that appropriately manipulate the half scale data to achieve the desired pattern. See section Setting Custom Flat Field Coefficients for details.

Built-In Self-Test Codes

The Built-In Self-test (BIST) codes are located in the Camera Information pane.

Note. Items in italics are specific to the internal hardware of the camera and will only be useful to the User when communicating potential issues with Teledyne DALSA technical support team.

What each flag signifies:

BIST Error Description	Status Code (Bit Set)	Potential Cause
------------------------	-----------------------	-----------------

SUCCESS	0x00000000	No errors detected
I2C Error	0x00000001	Camera internal hardware
FPGA_NO_INIT	0x00000002	Camera internal hardware
FPGA_NO_DONE	0x00000004	Camera internal hardware
EXT_SRAM ERROR	0x00000008	Camera internal hardware
ECHO_BACK ERROR	0x00000010	Camera internal hardware
FLASH_TIMEOUT	0x00000020	Camera internal hardware
FLASH_ERROR	0x00000040	Camera internal hardware
NO_FPGA_CODE	0x00000080	Camera internal hardware
NO_COMMON_SETTINGS	0x00000100	Camera internal hardware
NO_FACTORY_SETTINGS	0x00000200	Camera internal hardware
OVER_TEMPERATURE	0x00000400	The camera has detected excessive internal temperatures and has partially shut down for protection. Remove power to recover and improve airflow over the camera fins
(Reserved)	0x00000800	-
NO_USER_FPN	0x00001000	The user has yet to save any FPN calibration data to a User Set. (Note. Default values should have been set by the factory)
NO_USER_PRNU	0x00002000	The user has yet to save any PRNU calibration data to a User Set. (Note. Default values should have been set by the factory)
CLHS_TXRDY_RETRY	0x00004000	The camera cannot establish CLHS communications with the frame grabber. Check the CLHS connection integrity.
INVALID_UPGRADE	0x00008000	An invalid file format or type was used when trying to upgrade software or coefficients.
NO_USER_SETTINGS	0x00010000	The User has yet to save a User Set (Note. Default values should have been set by the factory)
NO_ADC_COEFFICIENTS	0x00020000	Camera internal hardware
NO_SCRIPT	0x00040000	Camera internal hardware
MAIN_BIST_NO_LINEARITY_COEFFICIENTS	0x00080000	Camera internal hardware
MAIN_BIST_GRRST_DISABLED	0x00100000	Camera internal hardware
MAIN_BIST_NO_LUT	0x00200000	Camera internal hardware
MAIN_BIST_NO_FACT_PRNU	0x00400000	Camera internal hardware

Status LED

A single red/green LED is located on the back of the camera to indicate status.

LED State	Description
Off	Camera not power up or waiting for the software to start
Constant Red	The camera BIST status is not good. See BIST status for diagnosis.
Blinking Red	The camera has shut down due to an over temperature condition.
Blinking Orange	Powering Up. The microprocessor is loading code.
Blinking Green	Hardware is good, but the CLHS connection has not been established or has recently

	been broken.
Constant Green	The CLHS Link has been established and data transfer may begin

Resolving Camera Issues

Communications

No Camera Features when Starting CamExpert

If the camera's CamExpert GUI is opened and no features are listed, then the camera may be experiencing lane lock issues.

While using the frame grabber CamExpert GUI you should be able to see a row of status indicators below the image area that indicates the status of the CLHS communications. These indicators include seven lane lock status and a line valid (LVAL) status.

If the status for one or more lane locks is red, then there is likely an issue with the CLHS connectors at the camera and / or frame grabber. Ensure that the connectors are fully engaged and that the jack screws are tightened. Ensure that you are also using the recommended cables.

No LVAL

If the LVAL status is red and all lane locks are green, then there may be an issue with the camera receiving the encoder pulses.

1. From the Camera CamExpert > Digital I/O Control tab, select Internal Trigger Mode and set the CamExpert > Camera Control tab Acquisition Line Rate to the maximum that will be used.
2. The trigger signal from the frame grabber will not be used and the LVAL status should now be green. This will confirm the integrity of the image data portion of the CLHS cabling and connectors.
3. From the Camera CamExpert > Digital I/O Control tab, select External Trigger Mode.
4. From the Frame Grabber CamExpert > Advanced tab, select the Line Sync Source to be Internal Line Trigger and the Internal Line Trigger frequency to the maximum that will be used.
5. The trigger source is now being generated by the frame grabber and the LVAL status should be green. This will confirm the integrity of the General Purpose I / O portion of the CLHS cabling and connectors.
6. From the Frame Grabber CamExpert > Advanced tab, select the Line Sync Source to be External Line Trigger and select the Line Trigger Method to Method 2 under the same tab.
7. From the Frame Grabber CamExpert > External Trigger tab, select External Trigger to be enabled. If LVAL status turns red, check the following:
 - a. Is the transport system moving such that encoder pulses are being generated?
 - b. Has the encoder signal been connected to the correct pins of the I / O connector of the frame grabber? See the XTNUM frame grabber user manual for details.
 - c. Do the encoder signal levels conform to the requirements outlined in the XTNUM frame grabber user manual?

Image Quality Issues

Vertical Lines Appear in Image after Calibration

The purpose of flat field calibration is to compensate for the lens edge roll-off and imperfections in the illumination profiles by creating a uniform response. When performing a flat field calibration, the camera must be imaging a flat white target that is illuminated by the actual lighting used in the application. Though the camera compensates for illumination imperfection, it will also compensate for imperfections such as dust, scratches, paper grain, etc. in the white reference. Once the white reference is removed and the camera images the material to be inspected, any white reference imperfections will appear as vertical stripes in the image. If the white reference had imperfections that caused dark features, there will be a bright vertical line during normal imaging. Similarly, bright features will cause dark lines. It can be very difficult to achieve a perfectly uniform, defect-free white reference. The following two approaches can help in minimizing the effects of white reference defects:

1. Move the white reference closer to or further away from the object plane such that it is out of focus. This can be effective if the illumination profile changes minimally when relocating the white reference.
2. If the white reference must be located at the object plane, then move the white reference in the scan direction or sideways when flat field calibration is being performed. The camera averages several thousand lines when capturing calibration reference images so any small imperfections are averaged out.
3. Use the camera's flat field calibration filter feature, as detailed in the user manual Flat Field Calibration Filter section. This algorithm implements a low pass moving average that covers several adjacent pixels. This filter can help minimize the effects of minor imperfections in the white reference. Note: this filter is NOT USED in normal imaging.

Over Time, Some Pixels Develop Low Response

When flat field calibration is performed with a white reference as per the guidelines in the user manual, all pixels should achieve the same response. However, over time, dust within the lens extension tube may migrate to the sensor surface thereby reducing the response of certain pixels. If the dust particles are very small, they may have only a minor effect on responsivity, but still produce vertical dark lines that interfere with defect detection and need to be corrected.

Repeating the flat field calibration with a white reference may not be practical with the camera installed in the system. The camera has a feature where the flat field coefficients can be downloaded to the host PC and adjusted using a suitable application, such as Microsoft Excel. (See section Setting Custom Flat Field Coefficients for details. If the pixel location that has a low response can be identified from the image, then the correction coefficient of that pixel can be adjusted, saved as a new file, and then uploaded to the camera, thereby correcting the image without performing flat field calibration.

See the user manual for details on downloading and uploading camera files using CamExpert.

Note that dust accumulation on the lens will not cause vertical lines. However, heavy accumulation of dust on the lens will eventually degrade camera responsivity and focus quality.

Smearred & Distorted Images

The camera achieves its high responsivity by accumulating 4, 8 or 12 lines in the sensor. To achieve a well-defined image, the multiple lines are summed together in a manner that matches the motion of the image across the sensor. This synchronization is achieved by the user providing

an external synchronization (EXSYNC) signal to the camera, where one pulse is generated when the object moves by the size of one object pixel. See 'External Trigger Mode' in the user manual.

Any transport motion that is not correctly reflected in the EXSYNC pulses will cause image distortion in the scan direction. For standard line scan cameras, this type of image distortion may not greatly affect edge sharpness and small defect contrast, thereby having minimal impact on defect detection. However, TDI image quality is more sensitive to object motion synchronization errors. The following subsections discuss various causes for poor image quality as a result of EXSYNC not accurately reflecting object motion.

Continuously Smeared, Compressed or Stretched Images

When accurate synchronization is not achieved, the image will appear smeared in the scan direction. If the EXSYNC pulses are coming too fast, then the image will appear smeared and stretched in the machine direction. If the pulses are too slow, then the image will appear smeared and compressed. Check the resolution of the encoder used to generate the EXSYNC pulses along with the size of the rollers, pulleys, gearing, etc. to ensure that one pulse is generated for one pixel size of travel of the object.

It is also important that the direction of image travel across the sensor is per the camera's scan direction set by the user. See 'Scan Direction' in the user manual for more information. If the scan direction is incorrect, then the image will have a significant smear in the scan direction. Changing the scan direction to the opposite direction should resolve this problem. Refer to 'Camera Orientation' in the user manual to determine the correct direction orientation for the camera. Note that the lens has a reversing effect on motion. That is, if an object passes the lens-outfitted camera from left to right, the image on the sensor will pass from right to left. The diagrams in the user manual take the lens effect into account.

Randomly Compressed Images

It is possible that when the scan speed nears the maximum allowed, based on the exposure time used, the image will be randomly compressed and possibly smeared for small periods in the scan direction. This is indicative of the inspection systems transport mechanism dynamics causing momentary over-speed conditions. The camera can tolerate very short durations of over-speed but if it lasts too long, then the camera can only maintain its maximum line rate and some EXSYNC pulses will be ignored, resulting in the occasional compressed image.

The over-speeding may be due to inertia and / or backlash in the mechanical drive mechanism causing variations around the target speed. The greater the speed variation, the lower the target speed needs to be to avoid over-speed conditions. If the speed variation can be reduced by eliminating the backlash in the transport mechanism and / or optimizing the motor controller characteristics, then a higher target speed will be achievable.

Distorted Image when Stopping and Starting

The camera has a stop / start capability unique to TDI imaging and one that customers may not be familiar with. Further, this feature may expose motion issues in a system that were not visible previously. The camera is sensitive to any mismatch in object motion with respect to EXSYNC, as this will cause a smeared, distorted image. When the user is using the camera in a stop / start condition, great care must be taken to ensure that the EXSYNC pulses accurately reflect the object motion when stopping and starting occurs and that there is no momentary backwards motion. Any backlash in the transport mechanism could cause these types of problems due to acceleration transients when stopping and starting.

Below is an example of the precautions necessary to achieve a smooth start to imaging from a stopped condition using a non-ideal transport mechanism.

The test bench transport mechanism discussed here has an encoder which is an integrated part of the servo drive motor. There is a gear reduction and screw mechanism that attaches the motor / encoder to a slide that supports the object to be imaged. This setup includes some backlash between the slide and motor / encoder which creates an object motion to EXSYNC mismatch at the start and stop of travel. The whole test setup also vibrates for some time after it stops due to the acceleration transient. To achieve the best possible start up image quality with this non-ideal transport mechanism, the following precautions had to be taken with the transport control:

1. Before imaging was triggered, the transport was moved forward a few millimetres at a very slow speed and stopped to take up the slack.
2. The transport was then stopped for a sufficient time for the vibrations to die out.
3. Image capture could then be enabled and the transport ramped up to the target speed
4. S-Curve acceleration profiles were used to minimize rapid velocity changes.

Even with these precautions, some image distortion could still be seen. It is assumed that the user will have much better transport system than this demonstration test bench. However, users may still experience similar issues, especially when they working with very high object resolutions.

Distorted Image when Changing Direction

The camera achieves its high responsivity by accumulating 4, 8 or 12 rows within in the sensor in a fashion that accurately follows the object motion. When the scan direction changes the multiple line TDI accumulation process must reverse to match the reversed image motion across the sensor. Only when all rows being accumulated have received the same image will the output be correct. Prior to this some lines have been exposed to one direction and other lines exposed to the opposite direction in the accumulated output. The camera will output a number of invalid rows immediately after a direction change as follows:

Number of Rows Selected	Number of Invalid Rows After Direction Change
4	7
8	15
12	23

That is, when changing direction the first $2x \text{ #Rows} - 1$ should be ignored.
Notes:

1. The camera has a single line gap between each light sensitive row, thus the $2x \text{ #Rows} - 1$ invalid rows.
2. The camera does not drop invalid rows as some applications have issues when the number of EXSYNC pulses sent to the camera does not match the number of lines output from the camera.

Optical Misalignment Issues

As with all TDI cameras, image quality is sensitive to how accurate the image movement is aligned to the pixels as it tracks over each row of the sensor. The greater the number of rows, the more sensitive image quality will be to misalignment. The camera's maximum number of selectable rows is 12, which is far less than some CCD TDI cameras. However, maintaining accurate alignment should still be a priority.

The following sections detail the causes of possible image quality problems with respect to optical misalignment and how to identify them.

Image Will Not Focus Well over the Entire FOV

If the image is skewed with respect to the sensor pixel array, then a sharp image perpendicular to object travel will not be achievable regardless of attempts to adjust focus. This is due to a component of the image motion traveling in the long axis of the sensing array.

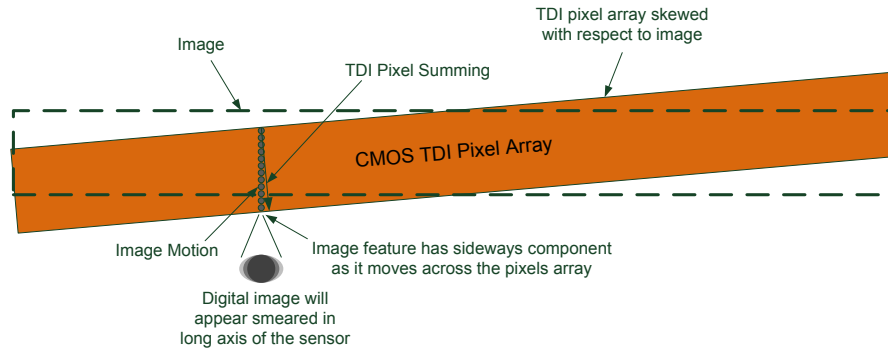

Figure 21 Effects of Camera Skew

The camera mounting assembly should have a mechanism to minimize any skew between the image motion and TDI summing direction.

For example, for 12 rows and no more than ¼ pixel movement along the long axis, skew will need to be less than $\tan^{-1} (0.25\text{pixel}/12\text{rows} + 11\text{spaces}) = 0.6^\circ$.

Image Will Not Focus at Edges of Field of View.

If sharp focus can be achieved at the centre of the image but not at the edges, this may be due to the camera’s optical axis not being perpendicular to the material surface in the scan direction. If the optical axis is not perpendicular, then this will cause a parallax issue at the edges of the field of view resulting in a component of image motion traveling in the long axis of the sensing array.

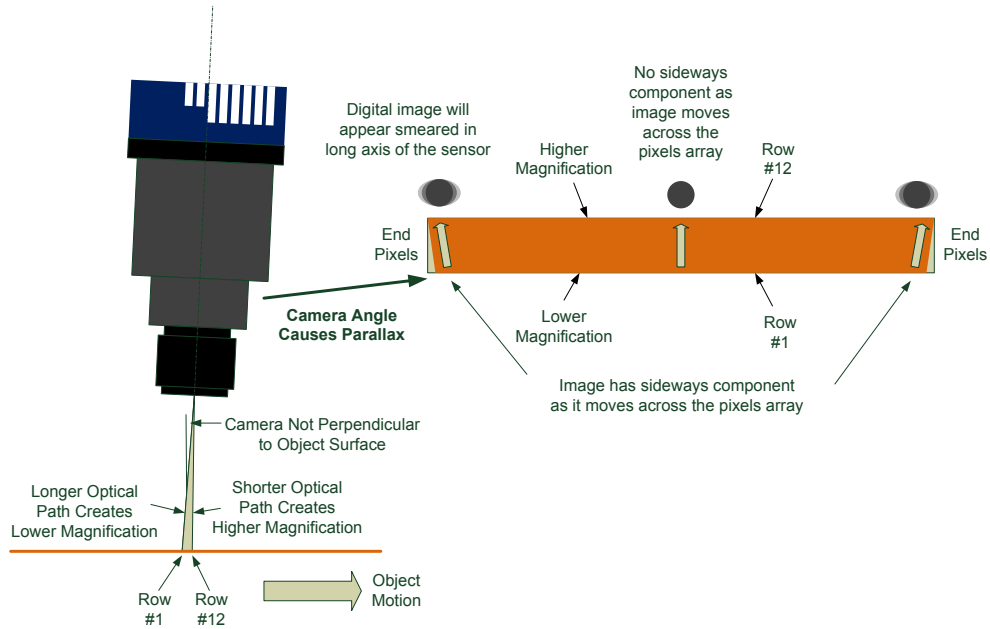

Figure 22 Effects of Camera Tilt in Scan Direction

Though the Piranha camera only has a maximum of 12 rows, the tolerable angle that does not cause a parallax issue is still quite small. For example, assume that a satisfactory image quality can be achieved with $\frac{1}{4}$ pixel sideways motion at the end pixels and a 120 mm lens with magnification of 0.5. This would require that the camera's optical axis to be within $\pm 3.5^\circ$ from perpendicular.

Note: If you have confirmed that the camera's optical axis is perpendicular to the material surface and you still have difficulty focusing at the edges, then check that the lens specification for MTF characteristics over the entire field of view. The MTF of lenses typically reduces at the edges of the field of view.

Image Will Focus Well on One Side but Not the Other at the Same Time

If sharp focus can be achieved at only one location of the sensors field of view and progressively gets worse from that point, then the camera may not be perpendicular to the object surface with respect to the long axis of the sensor.

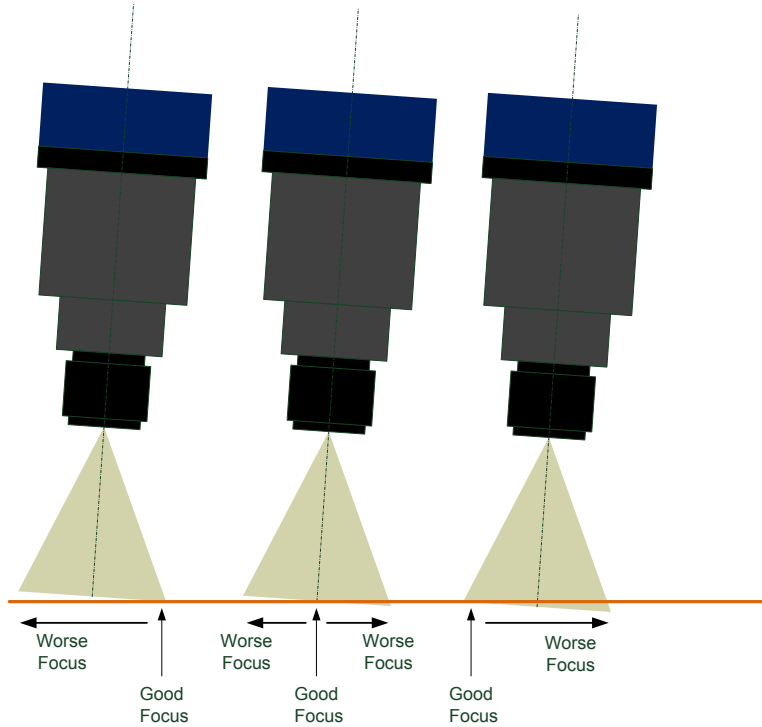

Figure 23 Effects of Camera Tilt In the Long Sensor Axis

A mechanical means to adjust this angle may need to be incorporated into the camera mount. This becomes a finer, more precise adjustment as the magnification increases, especially above 1x, as the depth of field becomes progressively smaller. The two examples below demonstrate this characteristic.

Assume the use of a 120 mm lens set at f5.6 and Circle of Confusion = 2 pixels.

Example A: Magnification of 0.5X

Depth of Field = 1.34mm

Field of View = $16352 \times 10\mu\text{m} = 163.52\text{mm}$

Requires the camera optical axis to be within $\pm 0.94^\circ$ from perpendicular

Example B: Magnification of 2X

Depth of Field = 0.042mm

Field of View = $16352 \times 2.5\mu\text{m} = 40.88\text{mm}$

Requires the camera optical axis to be within $\pm 0.12^\circ$ from perpendicular

Power Supply Issues

For reliable operation the camera input supply must be within +12 V to +24 V.

The power supply to the camera should be suitably current limited as per the applied input voltage of between +12 V to +24 V. Assume a worst case power consumption of 24 W and a 150% current rating for the breaker or fuse. Note that the camera will not start to draw current until the input supply is above approximately 10.5 V and 200 msec has elapsed. If the power supply stabilizes in less than 200 msec, then inrush current will not exceed normal operating current.

It is important to consider how much voltage loss occurs in the power supply cabling to the camera, particularly if the power cable is long and the supply is operating at 12V where the current draw is highest. Reading the input supply voltage as measured by the camera will give an indication of the supply drop being experienced.

The camera tolerates "hot" unplugging and plugging.

The camera has been designed to protect against accidental application of an incorrect input supply, up to reasonable limits. With the following input power issues, the status LED will be OFF.

- The camera will protect against the application of voltages above approximately +28 V. If the overvoltage protection threshold is exceeded, then power is turned off to the camera's internal circuitry. The power supply must be recycled to recover camera operation. The input protection circuitry is rated up to an absolute maximum of +30 V. Beyond this voltage, the camera may be damaged.
- The camera will also protect against the accidental application of a reverse input supply up to a maximum of -30 V. Beyond this voltage, the camera may be damaged

Causes for Overheating & Power Shut Down

For reliable operation, the camera's face plate temperature should be kept below 65°C and the internal temperature kept below 70°C.

Many applications, such as in clean rooms, cannot tolerate the use of forced air cooling (fans) and therefore must rely on convection. The camera's body has been designed with integrated heat fins to assist with convection cooling. The fins are sufficient to keep the camera at an acceptable temperature if convection flow is unimpeded. The camera also benefits by conducting heat away via the face plate into the lens extension tubes and camera mount. It is therefore important not to restrict convection airflow around the camera body, especially the fins and the lens assembly and camera mount. Lowering the ambient temperature will equally lower the camera's temperature.

If the camera's internal temperature exceeds 80 °C, then the camera will partially shut down to protect against damage.

Commands can still be sent to the camera to read the temperature, but the image sensor will not be operational and LVAL in response to line triggers will not be generated. Additionally, the camera's power will reduce by approximately 70% of normal operation. If the camera's temperature continues to rise, at 90°C the camera will further reduce its power to approximately 30% of normal operation and any communication with the camera will not be possible. The only means to recover from a thermal shutdown is to turn the camera's power off. Once the camera has cooled down, the camera data can be restored by re-applying power to the camera.

Declaration of Conformity



EC & FCC DECLARATION OF CONFORMITY

We :
Teledyne DALSA inc.
605 McMurray Road,
Waterloo, Ontario, Canada,
N2V 2E9

Declare under sole legal responsibility that the following products conform to the protection requirements of council directive 2004/108/EC (2014/30/EU after April 2016) on the approximation of the laws of member states relating to electromagnetic compatibility and are CE-marked accordingly:

Piranha XL, PX-HM-16K06X-00-R, PX-HM-16K12X-00-R

The products to which this declaration relates are in conformity with the following relevant harmonized standards, the reference numbers of which have been published in the Official Journal of the European Communities:

EN55032 (2012)	Electromagnetic compatibility of multimedia equipment — Emission requirements
EN55011 (2009) with A1(2010)	Industrial, scientific and medical equipment — Radio-frequency disturbance characteristics — Limits and methods of measurement
EN 61326-1 (2013)	Electrical equipment for measurement, control and laboratory use — EMC requirements — Part 1: General requirements
EN 55024 (2010)	Information technology equipment — Immunity characteristics — Limits and methods of measurement

Further declare under our sole legal responsibility that the product listed also conforms to the following international standards:

CFR 47	part 15 (2008), subpart B, for a class A product. Limits for digital devices
ICES-003	Information Technology Equipment (ITE) — Limits and Methods of Measurement
CISPR 11	Industrial, scientific and medical equipment - Radio-frequency disturbance characteristics - Limits and methods of measurement
CISPR 32	Electromagnetic compatibility of multimedia equipment - Emission requirements

Note: this product is intended to be a component of a larger system.

Waterloo, Canada
Location

2015-08-25
Date



Hank Helmond,
Director, Quality Assurance

THIS IS AN UNCONTROLLED COPY OF A CONTROLLED DOCUMENT PRINTED 2/19/2015 11:33 AM
The information contained herein is proprietary to TELEDYNE DALSA and is to be used solely for the purpose for which it is supplied. It shall not be disclosed in whole or in part, to any other party, without the express permission in writing by TELEDYNE DALSA.

Document Revision History

Revision	Description	Date
00	<ul style="list-style-type: none">Initial release of the XDR version of the manual.For the user manual describing the high gain camera model— PX-HM-16K12B-00-R—see document 03-032-20216.	February 19, 2016
01	<ul style="list-style-type: none">Backwards compatible software upgrade implemented. SFR ROI, Auto Black Enable, Calibrate Black Level, and Image Magnification Mode commands added and described.	October 31, 2016
02	<ul style="list-style-type: none">Removed unnecessary content.	December 15, 2017